

Installation guide – Spare parts and accessories

Overhaul kit | Code number 027H6180
 ICM, size 65A

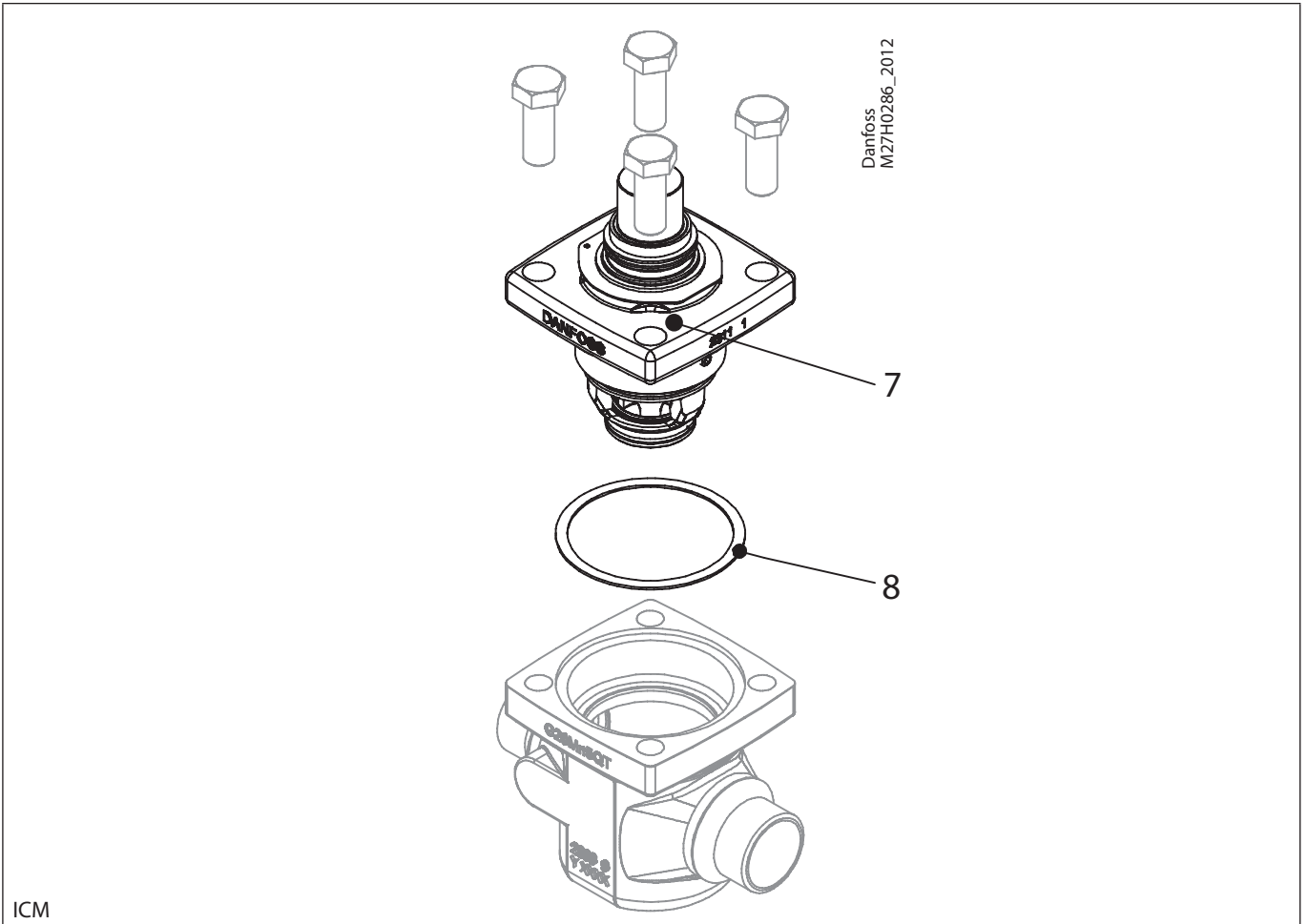

ICM

