

Ver.

| - -

„ORIGINAL INSTRUCTIONS“

IMPORTANT NOTE:

Read this manual carefully before installing or operating your new air conditioning unit. Make sure to save this manual for future reference.

EN

For downloading manual for this product, please enter the model name at this link:

**SK**

Pre stiahnutie manuálu k tomuto produktu zadajte modelové označenie do nasledujúceho odkazu:

**HR**

Za preuzimanje priručnika za ovaj proizvod unesite naziv modela na ovu vezu:

**SL**

Za prenos navodil za uporabo tega izdelka, vnesite ime modela na tej povezavi:

**IT**

Per scaricare il manuale di questo prodotto, inserisci il nome del modello a questo link:

**CZ**

Pro stažení manuálu k tomuto produktu zadejte modelové označení do následujícího odkazu:

**DE**

Um das Handbuch für dieses Produkt herunterzuladen, geben Sie bitte den Modellnamen für diesen Link ein:

**HU**

Termék kézikönyvének letöltéséhez írja be a modell megnevezését az alábbi linkre:

**RU**

Чтобы загрузить руководство для этого продукта, введите обозначение модели по следующей ссылке:

**ES**

Para descargar el manual de este producto, ingrese la designación del modelo en el siguiente enlace:



Contents

1 Safety Precautions.....	1
2 Outline of the Unit and Main Parts	2
3 Operation of remote controller.....	3
3.1 Buttons on remote controller	3
3.2 Introduction for icons on display screen.....	3
3.3 Introduction for buttons on remote controller.....	4
3.4 Function introduction for combination buttons.....	8
3.5 Operation guide.....	9
3.6 Replacement of batteries in remote controller.....	9
4 Test Running	10
4.1 Trial Operation and Testing	10
5 Troubleshooting and Maintenance	12
5.1 Troubleshooting	12
5.2 Routine Maintenance	13

Please read this operating manual carefully before operating the unit.



Appliance filled with flammable gas R32.



Before use the appliance, read the owner's manual first.



Before install the appliance, read the installation manual first.



Before repair the appliance, read the service manual first.

The figures in this manual may be different with the material objects, please refer to the material objects for reference.

● The Refrigerant

- To realize the function of the air conditioner unit, a special refrigerant circulates in the system. The used refrigerant is the fluoride R32, which is specially cleaned. The refrigerant is flammable and inodorous. Furthermore, it can lead to explosion under certain conditions. But the flammability of the refrigerant is very low. It can be ignited only by fire.
- Compared to common refrigerants, R32 is a nonpolluting refrigerant with no harm to the ozoneosphere. The influence upon the greenhouse effect is also lower. R32 has got very good thermodynamic features which lead to a really high energy efficiency. The units therefore need a less filling.

WARNING:

Do not use means to accelerate the defrosting process or to clean, other than those recommended by the manufacture. Should repair be necessary, contact your nearest authorized Service Centre.

Any repairs carried out by unqualified personnel may be dangerous.

The appliance shall be stored in a room without continuously operating ignition sources. (for example: open flames, an operating gas appliance or an operating electric heater.)

Do not pierce or burn.

Appliance shall be installed, operated and stored in a room with a floor area larger than "X" m² (see table 1). (only applies to appliances that are not fixed appliances)



Appliance filled with flammable gas R32. For repairs, strictly follow manufacturer's instructions only.

Be aware that refrigerants not contain odour.

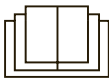
Read specialist's manual.



1 Safety Precautions

 WARNING!	This mark indicates procedures which, if improperly performed, might lead to the death or serious injury of the user.
 CAUTION!	This mark indicates procedures which, if improperly performed, might possibly result in personal harm to the user, or damage to property.

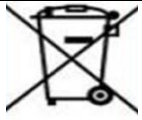
 WARNING!	
(1).	For operating the air conditioner pleasantly, install it as outlined in this installation manual.
(2).	Connect the indoor unit and outdoor unit with the room air conditioner piping and cord available from our standard parts. This installation manual describes the correct connections using the installation set available from our standard parts.
(3).	Installation work must be performed in accordance with national wiring standards by authorized personnel only.
(4).	If refrigerant leaks while work is being carried out, ventilate the area. If the refrigerant comes in contact with a flame, it produces toxic gas.
(5).	Do not power on until all installation work is complete.
(6).	During installation, make sure that the refrigerant pipe is attached firmly before you run the compressor. Do not operate the compressor under the condition of refrigerant piping not attached properly with 2-way or 3-way valve open. This may cause abnormal pressure in the refrigeration cycle that leads to breakage and even injury.
(7).	During the pump-down operation, make sure that the compressor is turned off before you remove the refrigerant piping. Do not remove the connection pipe while the compressor is in operation with 2-way or 3-way valve open. This may cause abnormal pressure in the refrigerant cycle that leads to breakage and even injury.
(8).	When installing and relocating the air conditioner do not mix gases other than the specified refrigerant (R32) to enter the refrigerant cycle. If air or other gas enters the refrigerant cycle, the pressure inside the cycle will rise to an abnormally high value and cause breakage, injury, etc.
(9).	This appliance can be used by children aged from 8 years and above and persons with reduced physical, sensory or mental capabilities or lack of experience and knowledge if they have been given supervision or instruction concerning use of the appliance in a safe way and understand the hazards involved. Children shall not play with the appliance. Cleaning and user maintenance shall not be made by children without supervision.
(10).	If the supply cord is damaged, it must be replaced by the manufacturer, its service agent or similarly qualified persons in order to avoid a hazard.
(11).	Correct Disposal of this product
(12).	The appliance shall not be installed in the laundry.
 GWP: R32:675	This marking indicates that this product should not be disposed with other household wastes throughout the EU. To prevent possible harm to the environment or human health from uncontrolled waste disposal, recycle it responsibly to promote the sustainable reuse of material resources. To return your used device, please use the return and collection systems or contact the retailer where the product was purchased. They can take this product for environmental safe recycling.

2 Outline of the Unit and Main Parts

Indoor

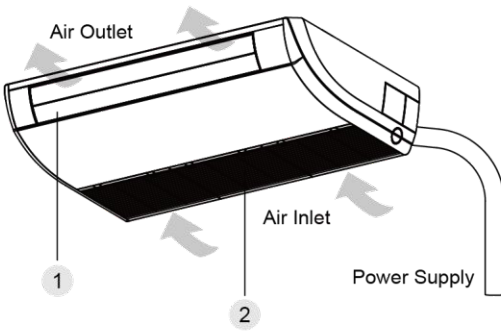

Outdoor

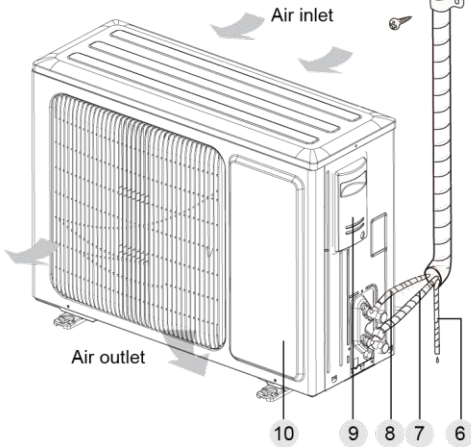

- 1. Guide louver
- 2. Air filter
- 3. Wired controller
- 4. Wireless Controller
- 5. Binding tape
- 6. Drain Pipe
- 7. Gas Pipe
- 8. Lipid Pipe
- 9. Big Handle
- 10. Front Board

Fig.1

Notes: The connection pipe and duct for this unit should be prepared by the user.

3 Operation of remote controller

3.1 Buttons on remote controller



- ① ON/OFF button
- ② MODE button
- ③ +/- button
- ④ FAN button
- ⑤ I FEEL button
- ⑥ ↑ button
- ⑦ ↻ button
- ⑧ 🌬️ button
- ⑨ CLOCK button
- ⑩ TIMER ON/TIMER OFF button
- ⑪ X-FAN button
Note: X-FAN is the same with BLOW
- ⑫ TEMP button
- ⑬ TURBO button
- ⑭ SLEEP button
- ⑮ LIGHT button

3.2 Introduction for icons on display screen

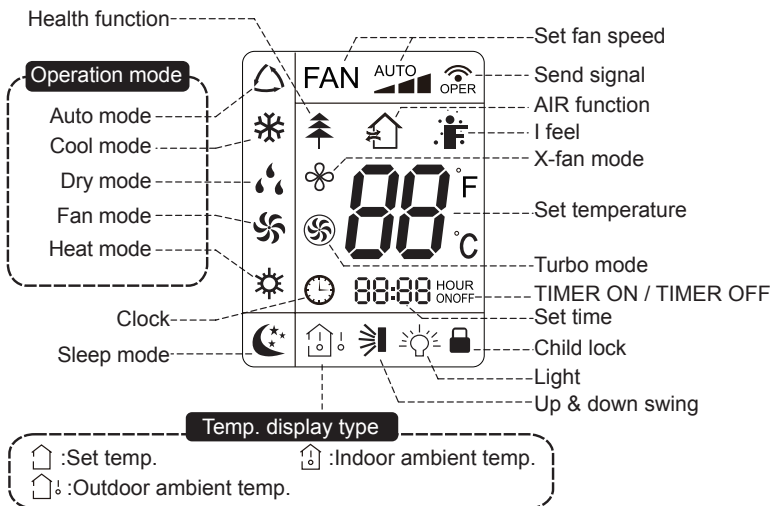

3.3 Introduction for buttons on remote controller

Note:

- This is a general use remote controller, it could be used for the air conditioners with multifunction; For some function, which the model doesn't have, if press the corresponding button on the remote controller that the unit will keep the original running status.
- After putting through the power, the air conditioner will give out a sound. After that, you can operate the air conditioner by using remote controller.

1 ON/OFF button

Press this button can turn on or turn off the air conditioner. After turning on the air conditioner, operation indicator "⏻" on indoor unit's display is ON (green indicator. The colour is different for different models), and indoor unit will give out a sound.

2 MODE button

Press this button to select your required operation mode.



- After selecting auto mode, air conditioner will operate automatically according to ambient temperature. Set temperature can't be adjusted and will not be displayed as well. Press "FAN" button can adjust fan speed. Press "↻" button can adjust fan blowing angle.
- After selecting cool mode, air conditioner will operate under cool mode. Press "+" or "-" button to adjust set temperature. Press "FN" button to adjust fan speed. Press "↻" button to adjust fan blowing angle.
- When selecting dry mode, the air conditioner operates at low speed under dry mode. Under dry mode, fan speed can't be adjusted. Press "↻" button to adjust fan blowing angle.
- When selecting fan mode, the air conditioner will only blow fan, no cooling and no heating. All indicators are OFF. Operation indicator is ON. Press "FAN" button to adjust fan speed. Press "↻" button to adjust fan blowing angle.
- When selecting heating mode, the air conditioner operates under heat mode. Press "+" or "-" button to adjust set temperature. Press "FAN" button to adjust fan speed. Press "↻" button to adjust fan blowing angle. (Cooling only unit won't receive heating mode signal. If setting heat mode with remote controller, press ON/OFF button can't start up the unit).

Note:

- For preventing cold air, after starting up heating mode, indoor unit will delay 1~5 minutes to blow air (actual delay time is depend on indoor ambient temperature).
- Set temperature range from remote controller: 16~30°C ; Fan speed: auto, low speed, medium speed, high speed.

3 +/- button

- Press "+" or "-" button once increase or decrease set temperature 1°C . Holding "+" or "-" button, 2s later, set temperature on remote controller will change quickly. On releasing button after setting is finished, temperature indicator on indoor unit will change accordingly. (Temperature can't be adjusted under auto mode)
- When setting TIMER ON, TIMER OFF or CLOCK, press "+" or "-" button to adjust time. (Refer to CLOCK, TIMER ON, TIMER OFF buttons) When setting TIMER ON, TIMER OFF or CLOCK, press "+" or "-" button to adjust time. (Refer to CLOCK, TIMER ON, TIMER OFF buttons)

4 FAN button

Pressing this button can set fan speed circularly as: auto (AUTO), low(▲) ,medium (▲▲), high(▲▲▲).



Note:

- Under AUTO Speed, IDU fan motor will adjust the fan speed (high, medium or low speed) according to ambient temperature.
- Fan speed under dry mode is low speed.

5 I FEEL button

Press this button to start I FEEL function and "I FEEL" will be displayed on the remote controller. After this function is set, the remote controller will send the detected ambient temperature to the controller and the unit will automatically adjust the indoor temperature according to the detected temperature. Press this button again to close I FEEL function and "I FEEL" will disappear.

- Please put the remote controller near user when this function is set. Do not put the remote controller near the object of high temperature or low temperature in order to avoid detecting inaccurate ambient temperature.
- When I FEEL function is turned on, the remote controller should be put within the area where indoor unit can receive the signal sent by the remote controller.

6 🌿 button

Press this button to set HEALTH function ON or OFF. After the unit is turned on, it defaults to HEALTH function ON.

- This function is applicable to partial of models.









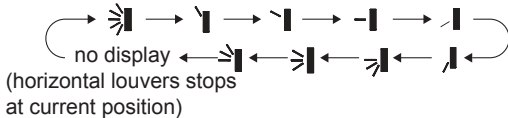



7 🏠 button

Press this button to select AIR function ON or OFF. (Only available for some models)



8 button

Press this button can select up&down swing angle. Fan blow angle can be selected circularly as below:





- When selecting "", air conditioner is blowing fan automatically. Horizontal louver will automatically swing up & down at maximum angle.
- When selecting ", , , , , , ", air conditioner is blowing fan at fixed position. Horizontal louver will stop at the fixed position.
- When selecting ", , ", air conditioner is blowing fan at fixed angle. Horizontal louver will send air at the fixed angle.
- Hold "" button above 2s to set your required swing angle. When reaching your required angle, release the button.

Note:

- ", , " may not be available. When air conditioner receives this signal, the air conditioner will blow fan automatically.

9 CLOCK button

Press this button to set clock time. "" icon on remote controller will blink. Press "+" or "-" button within 5s to set clock time. Each pressing of "+" or "-" button, clock time will increase or decrease 1 minute. If hold "+" or "-" button, 2s later, time will change quickly. Release this button when reaching your required time. Press "CLOCK" button to confirm the time. "" icon stops blinking.

Note:

- Clock time adopts 24-hour mode.
- The interval between two operation can't exceeds 5s. Otherwise, remote controller will quit setting status. Operation for TIMER ON/TIMER OFF is the same.

10 TIMER ON / TIMER OFF button

• TIMER ON button

"TIMER ON" button can set the time for timer on. After pressing this button, "" icon disappears and the word "ON" on remote controller blinks. Press "+" or "-" button to adjust TIMER ON setting. After each pressing "+" or "-" button, TIMER ON setting will increase or decrease 1min. Hold "+" or "-" button, 2s later, the time will change quickly until reaching your required time.

Press "TIMER ON" to confirm it. The word "ON" will stop blinking. "" icon resumes displaying. Cancel TIMER ON: Under the condition that TIMER ON is

started up, press "TIMER ON" button to cancel it.

- **TIMER OFF button**

"TIMER OFF" button can set the time for timer off. After pressing this button, "🕒" icon disappears and the word "OFF" on remote controller blinks. Press "+" or "-" button to adjust TIMER OFF setting. After each pressing "+" or "-" button, TIMER OFF setting will increase or decrease 1min. Hold "+" or "-" button, 2s later, the time will change quickly until reaching your required time. Press "TIMER OFF" word "OFF" will stop blinking. "🕒" icon resumes displaying. Cancel TIMER OFF. Under the condition that TIMER OFF is started up, press "TIMER OFF" button to cancel it.

Note:

- Under on and off status, you can set TIMER OFF or TIMER ON simultaneously.
- Before setting TIMER ON or TIMER OFF, please adjust the clock time.
- After starting up TIMER ON or TIMER OFF, set the constant circulating valid. After that, air conditioner will be turned on or turned off according to setting time. ON/OFF button has no effect on setting. If you don't need this function, please use remote controller to cancel it.

11 X-FAN button

Press this button under cool and dry mode to start up x-fan function, and "🌀" icon on remote controller will be displayed. Press this button again to cancel x-fan function, and "🌀" icon will disappear.

Note:

- When x-fan function is on, if the air conditioner is turned off, indoor fan will still operate at low speed for a while to blow the residual water inside the air duct.
- During x-fan operation, press X-FAN button to turn off x-fan function. Indoor fan will stop operation immediately.

12 TEMP button

By pressing this button, you can see indoor set temperature, indoor ambient temperature or outdoor ambient temperature on indoor unit's display. The setting on remote controller is selected circularly as below:

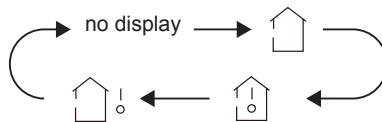



- When selecting "🏠🌡️" or no display with remote controller, temperature indicator on indoor unit displays set temperature.
- When selecting "🏠🌡️☀️" with remote controller, temperature indicator on indoor unit displays indoor ambient temperature.

-
- When selecting "," with remote controller, temperature indicator on indoor unit displays outdoor ambient temperature.



Note:

- Outdoor temperature display is not available for some models. At that time, indoor unit receives "" signal, while it displays indoor set temperature.
- It's defaulted to display set temperature when turning on the unit. There is no display in the remote controller.
- Only for the models whose indoor unit has dual-8 display.
- When selecting displaying of indoor or outdoor ambient temperature, indoor temperature indicator displays corresponding temperature and automatically turn to display set temperature after three or five seconds.



13 TURBO button

Under COOL or HEAT mode, press this button to turn to quick COOL or quick HEAT mode. "" icon is displayed on remote controller. Press this button again to exit turbo function and "" icon will disappear.

14 SLEEP button



Under COOL, HEAT mode, press this button to start up sleep function. "" icon is displayed on remote controller. Press this button again to cancel sleep function and "" icon will disappear.

15 LIGHT button

Press this button to turn off display light on indoor unit. "" icon on remote controller disappears. Press this button again to turn on display light. "" icon is displayed.

3.4 Function introduction for combination buttons

Child lock function

Press "+" and "-" simultaneously to turn on or turn off child lock function. When child lock function is on, "" icon is displayed on remote controller. If you operate the remote controller, the "" icon will blink three times without sending signal to the unit.

Temperature display switchover function

Under OFF status, press "-" and "MODE" buttons simultaneously to switch temperature display between °C and °F .

3.5 Operation guide

1. After putting through the power, press "ON/OFF" button on remote controller to turn on the air conditioner.
2. Press "MODE" button to select your required mode: AUTO, COOL, DRY, FAN, HEAT.
3. Press "+" or "-" button to set your required temperature. (Temperature can't be adjusted under auto mode).
4. Press "FAN" button to set your required fan speed: auto, low, medium and high speed.
5. Press "↻" button to select fan blowing angle.

3.6 Replacement of batteries in remote controller

1. Press the back side of remote controller marked with "OPEN", as shown in the fig, and then push out the cover of battery box along the arrow direction.
2. Replace two 7# (AAA 1.5V) dry batteries, and make sure the position of "+" polar and "-" polar are correct.
3. Reinstall the cover of battery box.

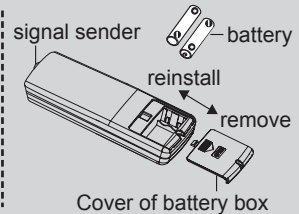

NOTICE

- During operation, point the remote control signal sender at the receiving window on indoor unit.
- The distance between signal sender and receiving window should be no more than 8m, and there should be no obstacles between them.
- Signal may be interfered easily in the room where there is fluorescent lamp or wireless telephone; remote controller should be close to indoor unit during operation.
- Replace new batteries of the same model when replacement is required.
- When you don't use remote controller for a long time, please take out the batteries.
- If the display on remote controller is fuzzy or there's no display, please replace batteries.

4 Test Running

4.1 Trial Operation and Testing

(1). The meaning of error codes as shown below:

Table 7

Number	Error code	Error
1	E1	Compressor high pressure protection
2	E2	Indoor anti-freeze protection
3	E3	Compressor low pressure protection, refrigerant lack protection and refrigerant collecting mode
4	E4	Compressor high discharge temperature protection
5	E5	AC over-current protection
6	E6	Communication error
7	E7	Mode conflict
8	E8	Anti-high temperature protection
9	F1	Indoor ambient temperature sensor is open/short circuited
10	F2	Indoor evaporator temperature sensor is open/short circuited
11	F3	Outdoor ambient temperature sensor is open/short circuited
12	F4	Outdoor condenser temperature sensor is open/short circuited
13	F5	Outdoor discharge temperature sensor is open/short circuited
14	C5	Jumper cap malfunction protection
15	EE	Loading EEPROM malfunction

Note: If there're other error codes, please contact qualified professionals for service. When the unit is connected with the wired controller, the error code will be simultaneously shown on it.

(2). Instructions to the Error Indicating Lamps on the Panel of the Floor Ceiling Type Unit.



Fig. 31

States of the Indicating Lamps:

①. Indicating Lamp of "POWER":

The indicating lamp will shine when power on, while it will go out when power off.

②. Indicating Lamp of "COOL" :

The indicating lamp will shine when "COOL" is activated, while it will go out when "COOL" is deactivated.

③. Indicating Lamp of "HEAT":

The indicating lamp will shine when "HEAT" is activated, while it will go out when "HEAT" is deactivated.

④. Indicating Lamp of "TIMER":

Timer indicator on indoor unit will be on when timer ON is set under off status and timer OFF is set under on status.

NOTE:

(1) If the light of indoor unit is turned off, when operating the remote controller to send command, the display will be on for 3s and then off.

(2) When the wired controller is connected, the indoor unit display is invalid and the unit won't receive the remote control command.

5 Troubleshooting and Maintenance

.1 Troubleshooting

If your air-conditioning unit suffers from abnormal operation or failure, please first check the following points before repair:

Table 9

Failure	Possible Reasons
The unit cannot be started.	<ul style="list-style-type: none">①. The power supply is not connected.②. Electrical leakage of air-conditioning unit causes tripping of the leakage switch.③. The operating keys are locked.④. The control loop has failure.
The unit operates for a while and then stops.	<ul style="list-style-type: none">①. There is obstacle in front of the condenser.②. The control loop is abnormal.③. Cooling operation is selected when the outdoor ambient temperature is above 46°C.
Poor cooling effect.	<ul style="list-style-type: none">①. The air filter is dirty or blocked.②. There is heat source or too many people inside the room.③. The door or window is open.④. There is obstacle at the air intake or outlet.⑤. The set temperature is too high.⑥. There is refrigerant leakage.⑦. The performance of room temperature sensor becomes worse
Poor heating effect	<ul style="list-style-type: none">①. The air filter is dirty or blocked.②. The door or window is not firmly closed.③. The set room temperature is too low.④. There is refrigerant leakage.⑤. The outdoor ambient temperature is lower than -5°C.⑥. Control loop is abnormal.



Note: After carrying out the check of the above items and taking relevant measures to solve the problems found but the air-conditioning unit still does not function well, please stop the operation of the unit immediately and contact the local service agency designated by Gree. Only ask professional serviceman to check and repair the unit.

5.2 Routine Maintenance

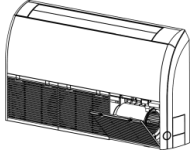
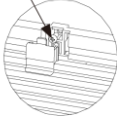

- ①. Do not turn off the unit and cut off the main power supply when cleaning the air conditioner, otherwise electric shock may happen.
- ②. Do not make the air conditioner wet or electric shock may be lead; Ensure that the air conditioner will not be cleaned by water rinsing under any circumstance.
- ③. Volatile liquid like thinner or gasoline would damage the appearance of air conditioner. (So, only soft dry cloth and wet cloth moistened by neutral cleaning fluid could be used to clean the surface panel of air conditioner.)

(1). Disassembly method of filter screen and electric box cover

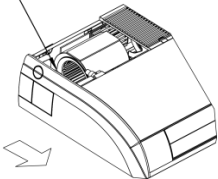
<p>1. Open the air inlet grille</p> <ol style="list-style-type: none"> ①. Firstly unfix two buckles on the grille as shown on the picture. ②. Remove the screws under the buckles by a screwdriver and then open the inlet grille. 	 <p>Remove the screw</p> 
<p>2. Clean the filter screen</p> <p>Clean the filter screen by a vacuum cleaner or wash it by flashing water. If the oil stain on the filter can not be removed or cleaned up, wash it by warm water meld with the detergent. Dry the filter in the shadow.</p> <p>Note: Never use hot water over 45℃ in case of color fading or turning yellow.</p> <p>Never dry it by fire so as to prevent the filter caught fire or deformation.</p>	
<p>3. Disassemble the left and right side board</p> <ol style="list-style-type: none"> ①. After the grille is removed, use a screwdriver to remove the screws shown on the picture. ②. Push the side plate as per the arrowed direction and take it down. 	<p>Remove the screw</p> 
<p>4. Disassemble the right side board</p>	<p>Disassembly method of right side board Step 3</p>

NOTE CONCERNING PROTECTION OF ENVIRONMENT



This product must not be disposed of via normal household waste after its service life, but must be taken to a collection station for the recycling of electrical and electronic devices. The symbol on the product, the operating instructions or the packaging indicate such disposal procedures. The materials are recyclable in accordance with their respective symbols. By means of re-use, material recycling or any other form of recycling old appliances you are making an important contribution to the protection of our environment. Please ask your local council where your nearest disposal station is located.

INFORMATION CONCERNING USED REFRIGERANT MEDIUM

This unit is containing fluorinated gases included in the Kyoto protocol. The maintenance and the liquidation must be carried out by qualified personnel.

Type of refrigerant: R32

The quantity of the refrigerant: Please see the unit label.

The value GWP: 675 (1 kg R32 = 0,675 t CO₂ eq)

GWP = Global Warming Potential



Appliance filled with flammable gas R32.

In case of quality problem or other please contact your local supplier or authorized service center.

Emergency number: 112

PRODUCER

SINCLAIR CORPORATION Ltd.

16 Great Queen Street

WC2B 5AH London

United Kingdom

www.sinclair-world.com

This product was manufactured in China (Made in China).

REPRESENTATIVE

SINCLAIR Global Group s.r.o.

Purkynova 45

612 00 Brno

Czech Republic

TECHNICAL SUPPORT

SINCLAIR Global Group s.r.o.

Purkynova 45

612 00 Brno

Czech Republic

Tel.: +420 800 100 285 | Fax: +420 541 590 124

www.sinclair-solutions.com | info@sinclair-solutions.com



EN

For downloading manual for this product, please enter the model name at this link:

**SK**

Pre stiahnutie manuálu k tomuto produktu zadajte modelové označenie do nasledujúceho odkazu:

**HR**

Za preuzimanje priručnika za ovaj proizvod unesite naziv modela na ovu vezu:

**SL**

Za prenos navodil za uporabo tega izdelka, vnesite ime modela na tej povezavi:

**IT**

Per scaricare il manuale di questo prodotto, inserisci il nome del modello a questo link:

**CZ**

Pro stažení manuálu k tomuto produktu zadejte modelové označení do následujícího odkazu:

**DE**

Um das Handbuch für dieses Produkt herunterzuladen, geben Sie bitte den Modellnamen für diesen Link ein:

**HU**

Termék kézikönyvének letöltéséhez írja be a modell megnevezését az alábbi linkre:

**RU**

Чтобы загрузить руководство для этого продукта, введите обозначение модели по следующей ссылке:

**ES**

Para descargar el manual de este producto, ingrese la designación del modelo en el siguiente enlace:





sinclair

AIR CONDITIONING