

# Energy Saving Solutions

for renovation of heating  
and cooling systems

**18** cases  
with payback time

calculations show you how fast  
your investment will be repaid  
by energy savings.

---

# Structure

0.1	Introduction	3
1.1	Recommended solution for heating systems	4
1.2	Recommended solution for cooling systems	6
2.1	Two-pipe heating system in long residential buildings	8
2.2	Two-pipe heating system in medium high residential buildings	10
2.3	Two-pipe heating system in medium high residential buildings	12
2.4	Two-pipe heating system in high residential buildings	14
2.5	Two-pipe heating system in medium high residential buildings	16
2.6	Two-pipe heating system in similar residential buildings	18
3.1	One-pipe heating system in special shaped medium high residential buildings	20
3.2	One-pipe heating system in special shaped medium high residential buildings	22
3.3	One-pipe heating system in special shaped medium high residential buildings	24
4.1	Domestic hot water system in long residential buildings	26
4.2	Domestic hot water system in long residential buildings	28
4.3	Domestic hot water system in high residential buildings	30
5.1	Cooling system comparison in special shaped office buildings	32
5.2	Cooling and heating system in medium high office building	34
5.3	AHU pumping cost comparison in commercial building (cooling application)	36
6.1	Energy saving in macro scale	38
6.2	Energy saving in macro scale	40
6.3	Energy saving in macro scale	42

---

# Introduction

The main reason of this Energy Saving Brochure is to answer the question whether investments in renovation of engineering systems like central heating, cooling or domestic hot water systems are economically responsible? When can return on investment be expected?

The development of this brochure is based on our customers' energy consumption before and after renovation collected during a period of multiple years. The information has been obtained from energy bills issued by heat or electric energy suppliers and is therefore reliable reference information that allows estimation of the effectiveness of the renovation.

When we analyzed the 18 presented cases, realistic costs were taken into consideration related to designing, purchasing and mounting of the equipment as well as launch costs when applicable.

All data was collected in a uniform method and special attention given to the different stages of renovation. Each case allows identification of what results can be expected per stage of renovation (e.g. mounting thermostatic radiator valves or balancing valves, etc.)

Upon receiving consent from our customers we have decided to provide precise information about cities and addresses where renovations has taken place. Firstly we would like to present transparent information to give the reader the possibility to check the presented data. Secondly to provide insight in the local costs for energy, and different prices for design, purchasing and installation of the equipment. Please keep in mind that these cost might differ from country to country.

In order to make calculations and comparisons of energy consumption we have used specialized methods of conversion (e.g. degree-day method) usually applied by energy auditors.

The presented cases are grouped according to themes:

**Chapter 2:** results obtained during renovation of typical two-pipe heating systems by mounting thermostatic radiator valves (RTD, RA and RTS) as well as automatic balancing valves (differential pressure regulators of ASV type). The differential pressure regulators provide a stable working condition for thermostatic radiator valves, which help achieve additional energy reductions while providing high indoor comfort.

**Chapter 3:** results obtained during renovation of one-pipe heating systems. Due to the specific character of these type of systems, besides using thermostatic radiator valves, different type of balancing valves has been used (AB-QM) which have been extended with thermostatic actuators (QT). With this combination of products it is possible to control the flow in the risers and balancing is done by control of return temperature.

**Chapter 4:** results obtained from renovation of domestic hot water systems by mounting multi-functional temperature control valves (MTCV). These valves provide thermostatic balancing of the system as well as reduction of the flow to an essential minimum in order to compensate heat losses and provide required temperature at the tap location.

**Chapter 5:** results obtained from renovation of cold water supply systems in air conditioning systems for air-handling units (AHU) and fan coil units (FCU). In these systems we have applied pressure independent pressure and control valves (AB-QM).

**Chapter 6:** results obtained from renovation in macro scale to show the amount of generated energy, which can have considerable meaning for large, global projects (e.g. projects that are financed by government or thermo renovation funds). Modernization in macro scale include renovation of central heating systems, domestic hot water systems and district heating sub stations.

The return on investments periods that are presented vary from 6 months to 6 years depending on the application, building size and system type. It is worth mentioning that high profitability of the mentioned investments were achieved by the use of Danfoss products. We hope that the given examples will help in the decision making process related to renovations. Danfoss can assist you by recommending and offering the right solutions for each stage in renovation to optimize heating & cooling systems, improve the indoor comfort and achieve maximum energy savings.



1.1

Recommended solution for heating systems

HEATING SYSTEM

ONE PIPE system

Systems with or without TRV'S

RECOMMENDED ADJUSTABLE FLOW LIMITER: AB-QM, QT, CCR3



Systems with or without TRV'S

ACCEPTABLE MSV-BD LENO, MSV-B/S/O LENO



TWO PIPE system

Systems with TRV'S

Without presetting

RECOMMENDED ASV-P + ASV-I ASV-PV + ASV-I

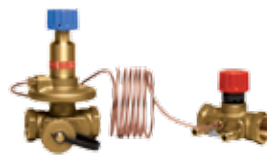

With presetting

RECOMMENDED ASV-P + ASV-M ASV-PV + ASV-M



RECOMMENDED ASV-PV + MSV-F2 (with impulse tube)



Sanitary water system

Systems without TRV'S

Upgrade to TRV'S not possible

RECOMMENDED  
MSV-B/S/O LENO,  
MSV-BD LENO  
/USV-I



Upgrade to TRV'S is possible

RECOMMENDED  
USV-M + USV-I  
(upgradable)



Domestic hot water circulation system

RECOMMENDED  
MTCV, CCR2





1.2

Recommended solution for cooling systems

COOLING SYSTEM

CONSTANT FLOW

Automatic balancing

Manual balancing

RECOMMENDED  
ADJUSTABLE FLOW  
LIMITER:  
AB-QM



ACCEPTABLE  
MSV-F2, MBV-BD LENO,  
MSV-B/O/S LENO



VARIABLE FLOW

Pressure controller

Fixed pressure

Adjustable pressure

Combined pressure independent control

Control valves with actuators and automatic adjustable flow limiter

RECOMMENDED

ASV-P + ASV-M



RECOMMENDED

ASV-PV + ASV-I

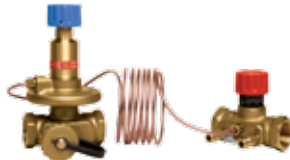

RECOMMENDED

AB-QM + TWA-Z  
AB-QM + ABNM  
AB-QM + AMV(E)



RECOMMENDED

ASV-PV (flange) + MSV-F2 (with impulse tube)





# STRONGLY RECOMMENDED INVESTMENT!

## 2.1

### Two-pipe heating system in medium high residential buildings

Type of building	Name of project	Main data	Picture of building
 Medium high building	<b>Building Society            "Na Skarpie"            Koszalin, Poland</b>	<ul style="list-style-type: none"> <li>• Address: Dąbroszczaków 3</li> <li>• Number of floors: 12</li> <li>• Number of staircases: 1</li> <li>• Number of flats: 68</li> <li>• Heated space: 13.885 m<sup>3</sup></li> <li>• Number of radiators: 637</li> <li>• Number of risers: 30</li> </ul>	

#### THE PROJECT

This building was built in 1977 with blocks of flat technology (concrete panels). The modernisation has been done in several steps. In 1994 TRV's and in 1995 heat cost allocators were installed on the radiators. In 1999 the wall was insulated. In 2002  $\Delta p$  controllers were installed in the bottom of the risers. In the investigated period the outdoor temperature was varying in a wide range therefore the correction of energy usage is very important.

#### USED DANFOSS EQUIPMENT FOR RENOVATION (IN 1996 AND 2002)

A | Thermostatic radiator valves for each radiator: RTD-N + thermo head RTD  
 Dimension: DN 10-20 (637 all together)



B | Differential pressure controller pair in the bottom of the riser: ASV-PV + ASV-M  
 Dimension: DN 15-32 (10, 5, 10, 5 pcs.)

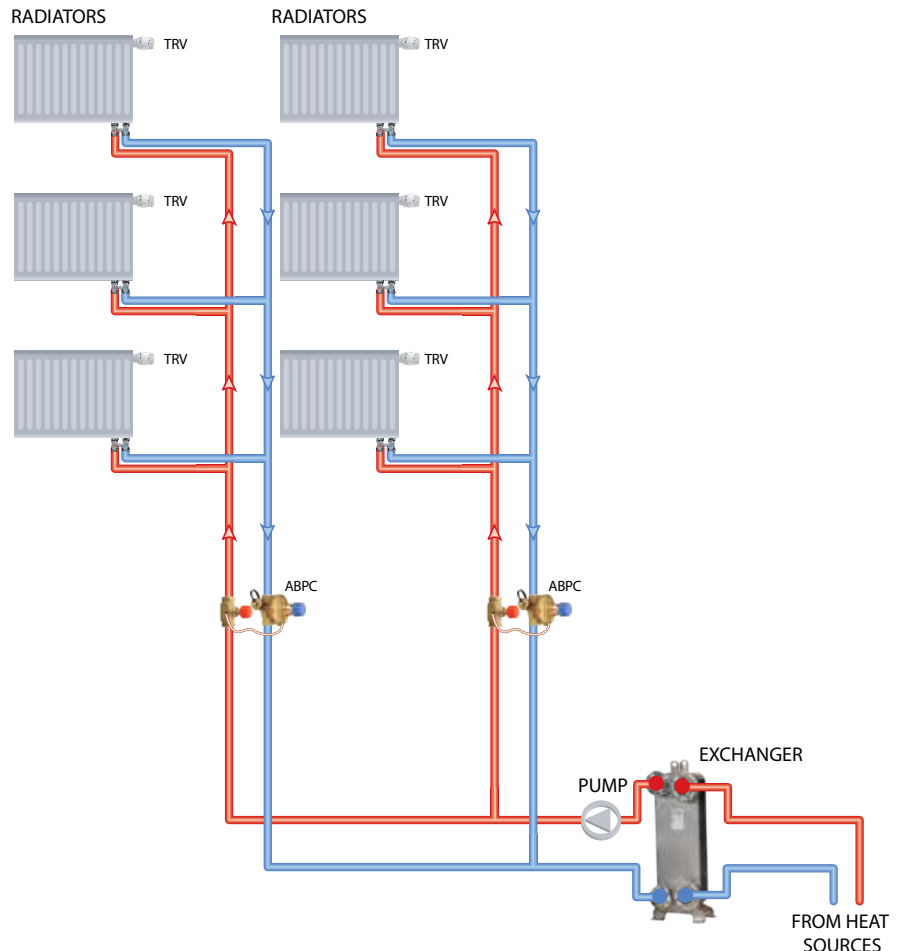
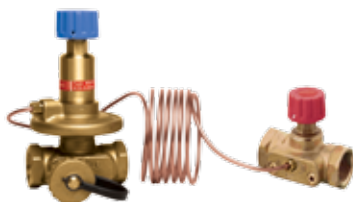

TRV – Thermostatic Radiator Valves  
 ABPC – Automatic Balancing Pressure Controller



## SAVINGS

Investment type	ASV Installation
Investment costs [€]	4947
Av. yearly energy saving [GJ]	383,2
Energy price (DH) [€/GJ]	8,2
<b>Pay back time [year]</b>	<b>1,6</b>

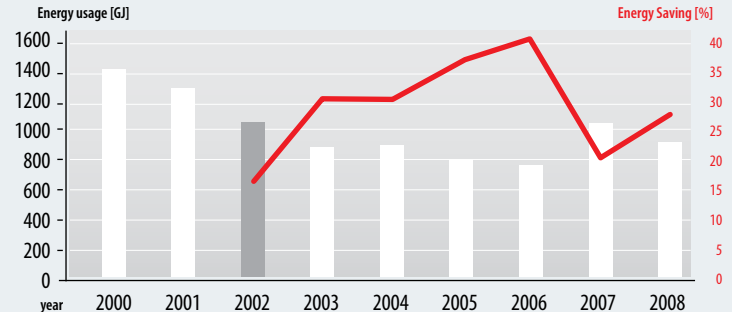

Calculation is based on year 2001 compared to 2002-2008

## INVESTMENT COSTS

Equipment	Pcs.	Price [€]	Installation costs [€]	Sum
Δp controller into the risers	30	4644	330	4947

## ENERGY USAGE AND ENERGY SAVING OF BUILDING

Year	Energy usage (heating) [GJ]	Corrected energy usage to 6,7°C	Saving in % compared to 2000	Saving in % due to automatic balancing valve comp. to 2001	Average outdoor temp. [°C]	Average energy saving [GJ]	Action
2000	1431	1431			6,70		
2001	1761	1296	9,5%		4,80		
2002	1466	1079	24,6%	16,7%	4,80		ASV installation
2003	1305	886	38,1%	31,7%	4,19	383,16	
2004	1173	895	37,5%	31,0%	5,05		
2005	1134	801	44,0%	38,2%	4,50		Roof insulation
2006	1131	769	46,3%	40,7%	4,20		
2007	1109	1031	28,0%	20,4%	6,30		
2008	1105	930	35,1%	28,3%	5,70		

## CONCLUSION

The installation of dedicated differential pressure controllers in the bottom of the risers bring an average of 31,3% energy saving on a yearly base. (The installation of ASV-PV valves is shown with a grey column in above diagram). In the year 2002 when the ASV installation was done, the energy saving is half of the average, due to the result of installation concerns a half season only.



The colder the outdoor temperature, the higher the energy saving will be, due to the Δp controller (year 2006). The roof insulation does not result in perceptible energy saving. (In a high building only a few flats are affected by this action). The pay back time of a Δp controller installation (less than 2 years) is very good.



# STRONGLY RECOMMENDED INVESTMENT!

## 2.2

### Two-pipe heating system in medium high residential buildings

Type of building	Name of project	Main data	Picture of building
 Medium high building	<b>Building Society "Wspólny Dom" Szczecin, Poland</b>	<ul style="list-style-type: none"> <li>• Address: Chopina 4</li> <li>• Number of floors: 11</li> <li>• Number of staircases: 1</li> <li>• Number of flats: 66</li> <li>• Heated space: 9.808 m<sup>2</sup></li> <li>• Number of radiators: 389</li> <li>• Number of risers: 26</li> </ul>	

#### THE PROJECT

This building was built in 1982 with blocks of flat technology (concrete panels). The modernisation has been done in several steps. In 1996 TRV's were installed in front of the radiators and in 2004 the wall and roof were insulated. In 2003 heat cost allocators were mounted onto the radiators. (In that time the manual balancing remained original). After further insulation, in 2005 the building was equipped with  $\Delta p$  riser controllers. In the investigated period the outdoor temperature was varying in a wide range therefore the correction of energy usage is very important.

#### USED DANFOSS EQUIPMENT FOR RENOVATION (IN 1996 AND 2005)

A | Thermostatic radiator valves for each radiator: RTD-N + thermo head RTD  
Dimension: DN 15 (389 pcs.)



B | Differential pressure controller pair in the bottom of the riser: ASV-PV + ASV-M  
Dimension: DN 15-25 (26 pcs.)

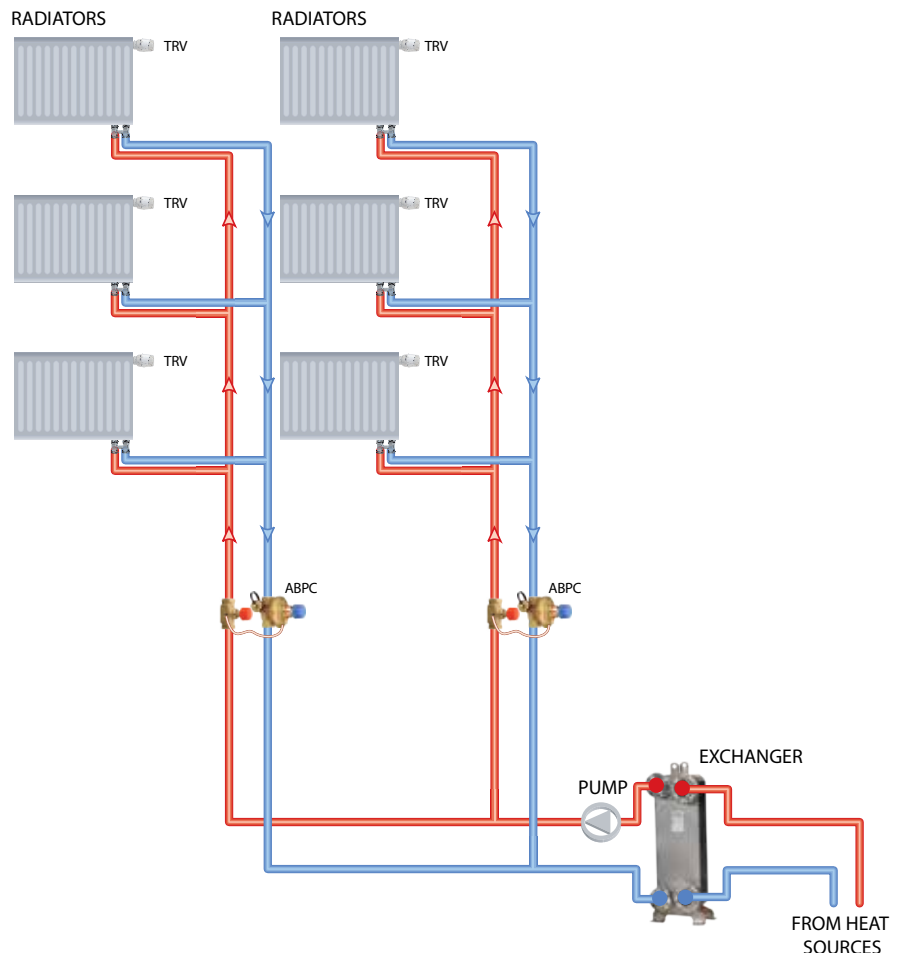
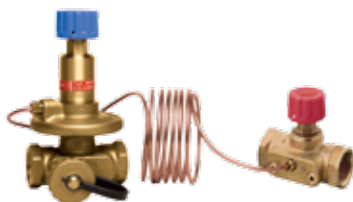

TRV – Thermostatic Radiator Valves  
ABPC – Automatic Balancing Pressure Controller

## SAVINGS

Investment type	ASV-PV/M
Investment costs [€]	3724
Av. yearly energy saving [GJ]	276,3
Energy price (DH) [€/GJ]*	13,2
<b>Pay back time [year]</b>	<b>1,0</b>

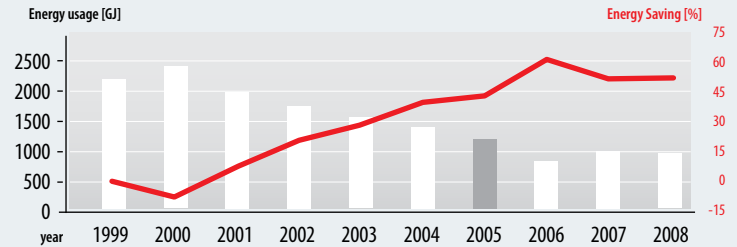

\* This price is based on local DH company price

## INVESTMENT COSTS

Equipment	Pcs.	Price [€]	Installation costs [€]	Sum
Δp controller into the risers	26	2550	1174	3724

## ENERGY USAGE AND ENERGY SAVING OF BUILDING

Year	Energy usage (heating) [GJ]	Corrected energy usage to 5,1°C	Saving in % compared to 1999	Saving due to automatic balancing copm. to 2003-2005	Average outdoor temp. [°C]	Average yearly energy saving (GJ)	Action
1999	2169	2169	0,0%		5,1		TRV installation in 1996
2000	1787	2348	-8,3%		6,75		-
2001	2045	2001	7,7%		4,95		
2002	1792	1712	21,1%		4,78		-
2003	1837	1534	29,3%		3,74		HCA* installation
2004	1354	1360	37,3%		5,13		Wall and roof insulation
2005	1141	1236	43,0%		5,63		ASV installation
2006	1024	868	60,0%	29,8%	3,86	276,3	
2007	851	1012	53,3%	18,1%	6,20		
* HCA – Heat Cost Allocator 2008	867	1000	53,9%	19,1%	6,02		

## CONCLUSION

With insulation of walls and roof in this building we can achieve significant energy saving (20-25%) With the application of heat cost allocators we are able to reduce the energy usage with another ~15%. The installation of dedicated differential pressure controllers in the bottom of the risers cause an average of 22% further energy saving on a yearly base. (The installation of ASV-PV valves is shown with a grey column in above diagram). The energy saving due to Δp controller is projecting in case of low outside temperature (year 2006). The pay back time of Δp controller installation (1 year) is very good.



# RECOMMENDED INVESTMENT!

## 2.3

### Two-pipe heating system in long residential buildings

Type of building	Name of project	Main data	Picture of building
 Long building	<b>Building Society "Wspólny Dom" Szczecin, Poland</b>	<ul style="list-style-type: none"> <li>• Address: Zakole 27-36</li> <li>• Number of floors: 5</li> <li>• Number of staircases: 10</li> <li>• Number of flats: 73</li> <li>• Heated space: 14.938 m<sup>3</sup></li> <li>• Number of radiators: 542</li> <li>• Number of risers: 104</li> </ul>	

#### THE PROJECT

This building was built in 1976 with blocks of flat technology (concrete panels). The modernisation has been done in several steps. In 1996 thermostatic radiator valves (TRV's) were installed in front of the radiators. The building was insulated step by step, in 1999 the end of the building, in 2004 the roof and the remaining walls in 2007. In 2003 heat cost allocators were mounted onto the radiators. (In that time the manual balancing system remained original). In 2005 the building was equipped with  $\Delta p$  riser controllers. In 2006 the domestic hot water (DHW) circulation was modernised with a return temperature limiter (see chapter 4.1).

#### USED DANFOSS EQUIPMENT FOR RENOVATION (IN 1996 AND 2005)

- A | Thermostatic radiator valves for each radiator: RTD-N + thermo head RTD  
Dimension: DN 15 (542 pcs.)



- B | Differential pressure controller pair in the bottom of the riser: ASV-PV + ASV-M  
Dimension: DN 15-25 (104 pcs.)

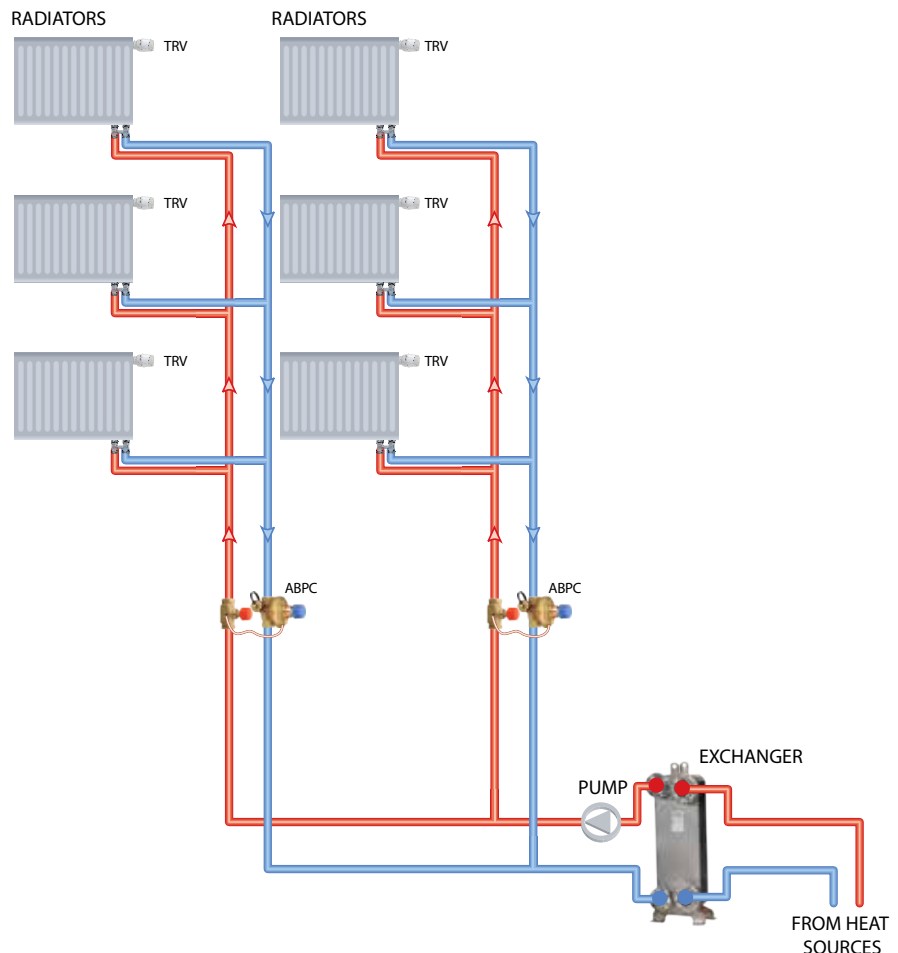
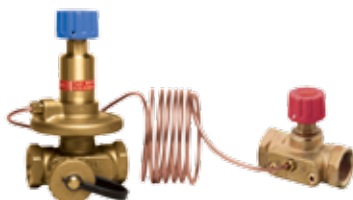

TRV – Thermostatic Radiator Valves  
ABPC – Automatic Balancing Pressure Controller

## SAVINGS

Investment type	ASV-PV/M
Investment costs [€]	16074
Av. yearly energy saving [GJ]	205,0
Energy price (DH) [€/GJ]*	13,2
<b>Pay back time [year]</b>	<b>5,9</b>

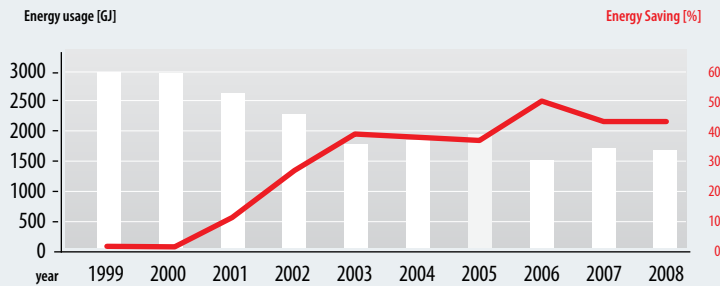

\* This price is based on local DH company price

## INVESTMENT COSTS

Equipment	Pcs.	Price [€]	Installation costs [€]	Sum
Δp controller into the risers	104	11640	434	16074

## ENERGY USAGE AND ENERGY SAVING OF BUILDING

Year	Energy usage (heating) [GJ]	Corrected energy usage to 5,1°C	Saving in % compared to 1999	Saving due to automatic balancing comp. to 2003-2005	Average outdoor temp. [°C]	Average yearly energy saving (GJ)	Action
1999	3026	3026	0,0%		5,1		part of wall insulation*
2000	2284	3002	0,8%		6,75		-
2001	2599	2544	15,9%		4,95		-
2002	2306	2203	27,2%		4,78		-
2003	2208	1845	39,0%		3,74		HCA** installation
2004	1860	1868	38,3%		5,13		roof insulation
2005	1755	1901	37,2%		5,63		ASV installation
2006	1794	1521	49,7%	18,7%	3,86		
2007	1468	1747	42,3%	6,7%	6,20	205,0	remaining wall insulation
2008	1501	1732	42,8%	7,5%	6,02		

\* TRV installation in 1996

\*\* HCA – Heat Cost Allocator

## CONCLUSION



With insulation of walls and roof we can achieve significant energy saving (15-25%). With the application of a heat cost allocator we are able to reduce the energy usage with another ~15%. The installation of dedicated pressure controllers in the bottom of the risers cause an average of 11% further energy saving on a yearly base. The energy saving due to Δp controller is projecting in case of low outdoor temperature (year 2006). The pay back time of Δp controller installation is acceptable (less than 6 years), to be taken into consideration that this is not a high building, thus one pressure differential controller handles 5 thermostatic radiator valves only.



# STRONGLY RECOMMENDED INVESTMENT!

## 2.4

### Two-pipe heating system in high residential buildings

Type of building	Name of project	Main data	Picture of building
 High building	<b>Building Society "Osiedle Młodych" Poznań, Poland</b>	<ul style="list-style-type: none"> <li>• Address: Tysiąclecia 70</li> <li>• Number of floors: 16</li> <li>• Number of staircases: 2</li> <li>• Number of flats: 128</li> <li>• Heated space: 19.500 m<sup>3</sup></li> <li>• Number of radiators: 576</li> <li>• Number of risers: 40</li> </ul>	

#### THE PROJECT

This building was built in 1983 with blocks of flat technology (concrete panels). The modernisation has been done in several steps. In 1995 TRV's and in 1996 heat cost allocators were installed on the radiators. In 1999 the wall became insulated. In 2005  $\Delta p$  controllers were installed in the bottom of the risers. In the investigated period the outdoor temperature was varying in a wide range therefore the correction of energy usage is very important.

#### USED DANFOSS EQUIPMENT FOR RENOVATION (IN 1995 AND 2005)

A | Thermostatic radiator valves for each radiator: RTD-N + thermo head RTD  
Dimension: DN 10-20 (576 all together)



B | Differential pressure controller pair in the bottom of the riser: ASV-PV + ASV-M  
Dimension: DN 15-32 (2, 4, 14, 20 pcs.)

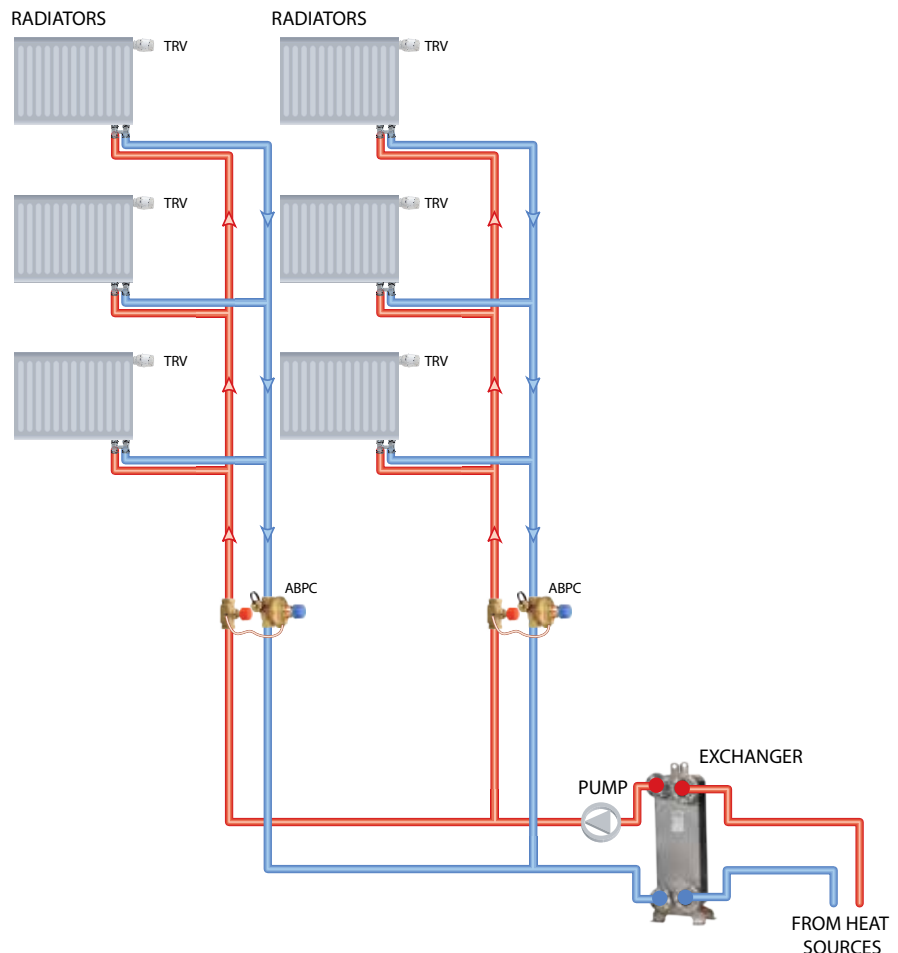
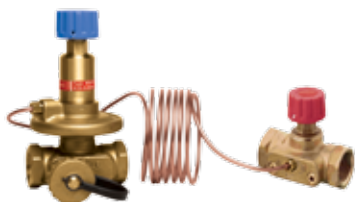

TRV – Thermostatic Radiator Valves  
ABPC – Automatic Balancing Pressure Controller

## SAVINGS

Investment type	ASV Installation
Investment costs [€]	6631
Av. yearly energy saving [GJ]	740,4
Energy price (DH) [€/GJ]	8,79
<b>Pay back time [year]</b>	<b>1,0</b>

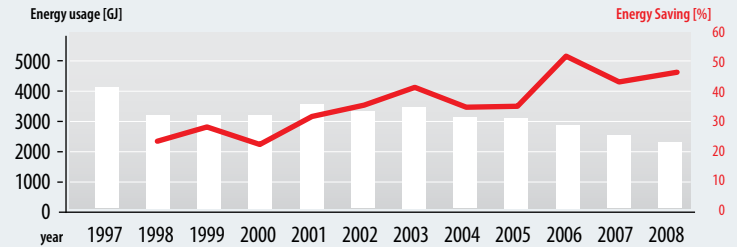

Calculation is based on period 1997 – 2004 compared to 2006-2008

## INVESTMENT COSTS

Equipment	Pcs.	Price [€]	Installation costs [€]	Sum
Δp controller into the risers	40	5597	1034	6631

## ENERGY USAGE AND ENERGY SAVING OF BUILDING

Year	Energy usage (heating) [GJ]	Corrected energy usage to 5,2°C	Saving in % compared to 1997	Extra saving in % due to automatic balancing (2005)	Average outdoor temp. [°C]	Average yearly energy saving (GJ)	Action
1997	4194	4194			5,2		1995 TRV, 1996 HCA installation
1998	3167	3697	24,5%		6,2		
1999	3358	2999	28,5%		4,4		Insulation of building
2000	3066	3264	22,2%		5,6		-
2001	3607	2873	31,5%		3,5		
2002	3328	2715	35,3%		3,7		-
2003	3488	2486	40,7%		2,5		
2004	3184	2661	36,5%		3,9		
2005	3026	2706	35,5%	9,8%	4,4		ASV installation
2006	2863	2075	50,5%	30,8%	2,7	740,44	
2007	2493	2411	42,5%	19,6%	5,0		
2008	2292	2161	48,5%	27,9%	4,8		

## CONCLUSION

The installation of dedicated differential pressure controllers in the bottom of the risers result in a 26,3% energy saving on a yearly base. (The installation of ASV-PV valves is shown with a grey column in above diagram). In the year 2005 when the ASV installation was done the energy saving is half of the average due to the result of installation concerns a half season only. The insulation of the building does not result in perceptible energy saving. (In high buildings only a few flats are affected by this action). The pay back time of a Δp controller installation (1 year) is very good.



# STRONGLY RECOMMENDED INVESTMENT!

## 2.5

### Two-pipe heating system in medium high residential buildings

Type of building	Name of project	Main data	Picture of building
 Medium high rise building	<b>Building Society "Katowicka"</b> <b>Katowice, Poland</b>	<ul style="list-style-type: none"> <li>• Address: Lubuska street 7-9</li> <li>• Number of floors: 11</li> <li>• Number of staircases: 2</li> <li>• Number of flats: 60</li> <li>• Heated space: 15612 m<sup>3</sup></li> <li>• Number of radiators: 294</li> <li>• Number of risers: 14</li> </ul>	

#### THE PROJECT

This building was built in 1987 with blocks of flat technology (concrete panel). The modernisation has been done in several steps. In 1996 TRV's and heat cost allocators were implemented (in that time the manual balancing remained original). In 2000 the sub-station was renovated (pressure controller). In 2002 the building was established with automatic balancing valves in the bottom of the risers ( $\Delta p$  controller). In 2005 the block sub-station was separated to a dedicated sub-sub-station for each building.

#### USED DANFOSS EQUIPMENT FOR RENOVATION (IN 1996 AND 2002)

A | Thermostatic radiator valves for each radiator: RTD-N + thermo head RTD  
 Dimension: DN 15



B | Differential pressure controller pair in the bottom of the riser: ASV-PV + ASV-M  
 Dimension: DN 15-32 (4, 3, 4, 3 pcs.)

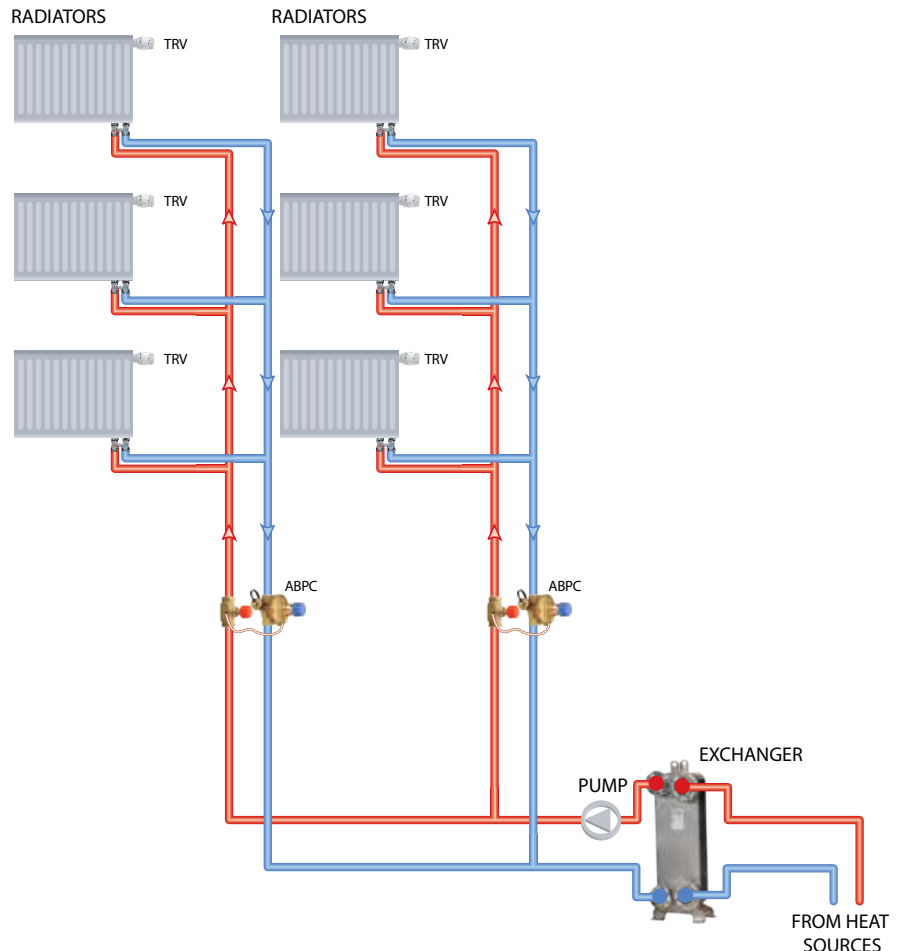
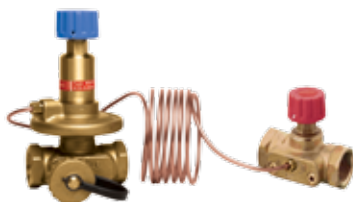

TRV – Thermostatic Radiator Valves  
 ABPC – Automatic Balancing Pressure Controller



## SAVINGS

Investment type	only TRV	ABV in S.St.**	ASV-P/M	Sum
Investment costs [€]	4816	1085	2410	7226
Av. yearly energy saving [GJ]	365,7	476,5	97,6	795,5
Energy price (DH) [€/GJ]*	6,49	6,49	6,49	6,49
<b>Pay back time [year]</b>	<b>2,0</b>	<b>0,4</b>	<b>3,8</b>	<b>1,4</b>

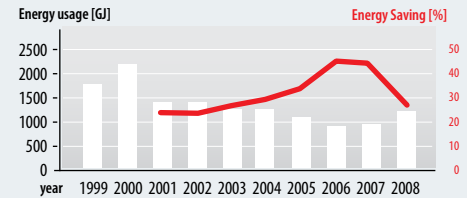

\* This price is based on local DH company price  
 \*\* S.St. – Sub Station

## INVESTMENT COSTS

Equipment	Pcs.	Price [€]	Installation costs [€]	Sum
Radiator valves (RTD)	294	2964	1117	4081
Heat cost allocator	294	735	0	735
Central Δp controller	1	685	400	1085
Δp controller into the risers (ASV-PV, ASV-M)	14	1892	518	2410

## ENERGY USAGE AND ENERGY SAVING OF BUILDING

Year	Energy usage (heating) [GJ]	Corrected energy usage to 2,4°C	Saving in % compared to 1995	Saving in % due to automatic balancing valve comp. to 1999	Extra saving in % due to automatic balancing (2002)	Average outdoor temp. [°C]	Energy saving in GJ comp. to previous period*	Action
1995	2084					2,4		
1996	2006	1945	6,7%			2,1		TRV, HCA installation
1997	1741	1878	9,9%			3,1		
1998	1760	1837	11,9%			2,8	365,7	
1999	1537	1757	15,7%			3,6		
2000	1505	2247	-7,8%			5,6		Δp contr. in sub-station
2001	1167	1347	35,4%	23,3%		3,7	476,5	
2002	1161	1348	35,3%	23,3%		3,7		ASV installation
2003	1275	1259	39,6%	28,3%	6,6%	2,3		
2004	1068	1240	40,5%	29,4%	8,0%	3,7	97,6	
2005	978	1126	46,0%	35,9%	16,5%	3,7		Sub-station separation
2006	960	945	54,6%	46,2%		2,3		
2007	676	980	53,0%	44,2%		5,4		
2008	853	1248	40,1%	28,9%		5,4		

## CONCLUSION



The energy saving potential is huge in these type of buildings. With TRV we can reduce the energy usage with more than 10%. In case of Δp controller in the building we can save another 23% of energy! With dedicated differential pressure controller in the bottom of the riser we can save an additional 6-8% of energy. (If the Δp controller had not been installed into the sub-station the saving would have appeared here like in previous cases). All together – because of the Δp controllers the total saving is close to 30%. The pay back time in this project was very low (less than two years), because of the automatic balancing in the risers.



# RECOMMENDED INVESTMENT!

## 2.6

### Two-pipe heating system in similar residential buildings

Type of building	Name of project	Main data	Picture of building
 <p>Two – same size and location – building comparison before and after renovation</p>	<p><b>Building Society NAZORA street Tuluza, Bosnia</b></p>	<ul style="list-style-type: none"> <li>• Address: Nazora 6 and 12</li> <li>• Number of floors: 5</li> <li>• Number of flats: 15</li> <li>• Heated space: 1971 m<sup>3</sup></li> <li>• Number of radiators: 50</li> <li>• Number of risers: 13</li> </ul>	

#### THE PROJECT

This building was built in 1962 with traditional building technology (brick walls). The modernisation has been done in the summer of 2005. During that time one of the buildings (V.Nazora 12) was equipped with TRV's, heat cost allocators and automatic balancing valves. The other building (V.Nazora 6) was renovated in the same way, but only with manual balancing in the bottom of the risers. The insulation of the buildings was not renovated, the wooden windows and doors are still original. The heat source of the buildings is district heating.

#### USED DANFOSS EQUIPMENT FOR RENOVATION (IN 2005)

A | Thermostatic radiator valves for each radiator: RA-N + thermo head RAE  
Dimension: DN 15 (50 pcs.)



B | Differential pressure controller pair in the bottom of the riser: ASV-P + ASV-M  
Dimension: DN 15-20 (5, 8 pcs.)

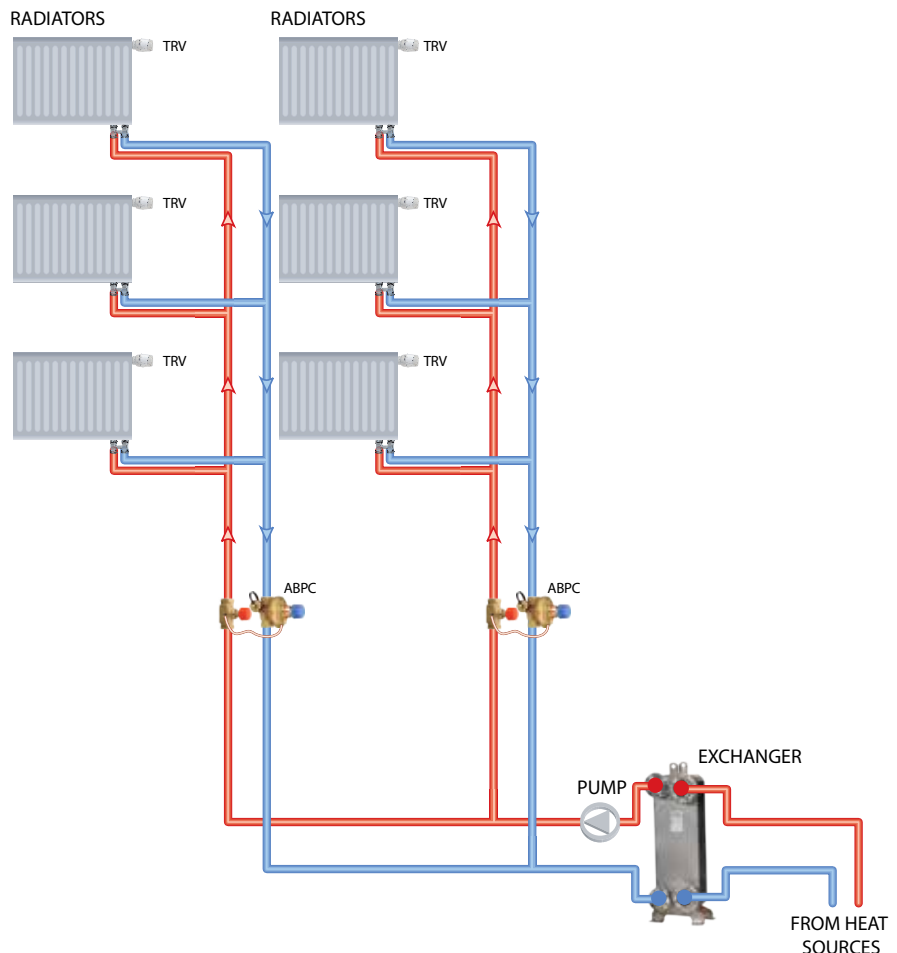
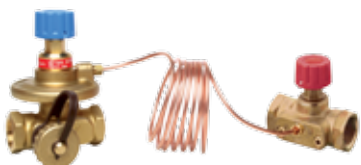

TRV – Thermostatic Radiator Valves  
ABPC – Automatic Balancing Pressure Controller

## SAVINGS

Investment type	ASV-P/M
Investment costs [€]	616
Av. yearly energy saving [GJ]	23,9
Energy price (DH) [€/GJ]	3,38
<b>Pay back time [year]</b>	<b>4,0</b>

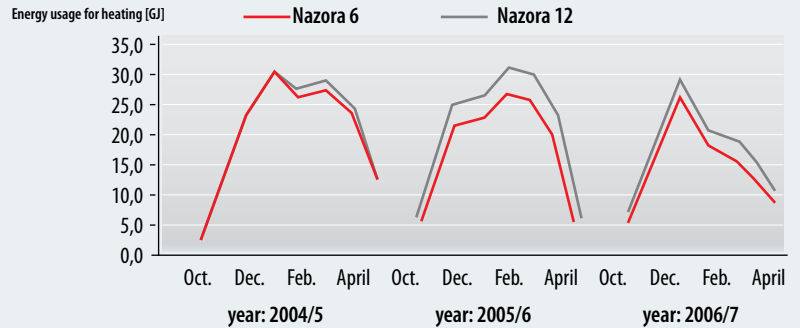

The investment costs difference between buildings: 1665-1049=616 EUR (based on price difference of balancing.)

## INVESTMENT COSTS

Equipment	Pcs.	Price [€]	Installation costs [€]	Sum	Remark
Δp controller into the risers	13	1103	562	1662	Nazora 12
Manual balancing	13	487	562	1049	Nazora 6
Radiator valves	50	404	190	594	In both buildings
Heat cost allocator	50	125	0	125	In both buildings

## ENERGY USAGE AND ENERGY SAVING OF BUILDING

Building	Energy usage (heating) [GJ]			Energy usage (heating) [GJ]		
	2004/2005	2005/2006	2006/2007	2004/2005	2005/2006	2006/2007
V. Nazora 6.				V. Nazora 12.		
Month/Year	2004/2005	2005/2006	2006/2007	2004/2005	2005/2006	2006/2007
October	2,7	7,7	7,1	2,5	6,0	5,2
November	22,6	24,9	18,4	22,6	21,0	14,2
December	30,3	26,5	29,5	30,8	23,2	24,4
January	27,3	31,3	20,6	29,5	27,2	16,9
February	29,0	30,0	18,7	30,7	25,7	14,4
March	23,5	23,1	15,6	24,2	18,9	11,9
April	12,0	7,2	10,2	12,3	6,2	7,8
Sum	147,4	150,7	120,1	152,5	128,2	94,8
Energy saving compared to V. Nazora 6.				-3,3%	17,5%	26,7%

## CONCLUSION

The energy saving potential is significant. With a heating system renovation (TRV+ABV) only we can reduce the energy usage around 20-30%. (With insulation and renovation of the windows further savings can be achieved). Very well visible on the above graph is that the original higher energy consumption of the building (dark grey line) is much lower than the building which wasn't renovated (red line). The pay back time of the investment is acceptable. Including the total heating renovation expenses, the pay back time is four years.



**IT IS WORTH CONSIDERING MAKING THE INVESTMENT!** The pay back time is in this case not outstanding, but good enough. We have to take into consideration the relatively low energy price, but also the increasing comfort.



# STRONGLY RECOMMENDED INVESTMENT!

## 3.1

### One-pipe heating system in special shaped medium high buildings

Type of building	Name of project	Main data	Picture of building
 Low building	<b>Wohnungsgesellschaft der Stadt Deelitzsch, Germany</b>	<ul style="list-style-type: none"> <li>• Address: str. Sonnenwinkelweg 2-8</li> <li>• Number of floors: 5</li> <li>• Number of flats: 40</li> <li>• Heated space: 6 840 m<sup>3</sup></li> <li>• Number of radiators: 180</li> <li>• Number of risers: 36</li> </ul>	

#### THE PROJECT

The building was built in 1982 with concrete panel technology. The heat systems used in this building was a typical one pipe system with bypass for flow control – as riser controller – only manual shut off valves were used. In 1992 the heating system was redesigned manual shut off valves were replaced for thermostatic radiator valves (RA-D type). In the same time heat cost allocators were implemented on each radiator, which allowed introducing individual energy consumption calculation. In 1995 a next step in thermo modernisation process was done: wall isolation and replacement of the windows. In 2006 the one pipe heating system was renovated again concerning the water distribution. This time automatic flow limiters (AB-QM) with thermal actuators (TWA) and thermostats on the pipe (AT-type) were installed in risers – for proper water balancing. In the same time a similar building, which is located near to the original project building, was left without riser balancing. So we could compare the energy efficiency of the renovated building. This type of solution allows controlling the return temperature. During a partly loaded condition, when some of the radiators are closed, the return temperature is increasing. This results in hot water that is circulating unnecessary in the system.

#### USED DANFOSS EQUIPMENT FOR RENOVATION (IN 1992 AND 2006)

- A | Thermostatic valves RA-D  
Dimension: DN 10-20 (180 pcs.)
- B | Automatic flow limiter AB-QM with TWA actuators  
Dimension: DN 15 (36 pcs.)  
and AT thermostat elements.

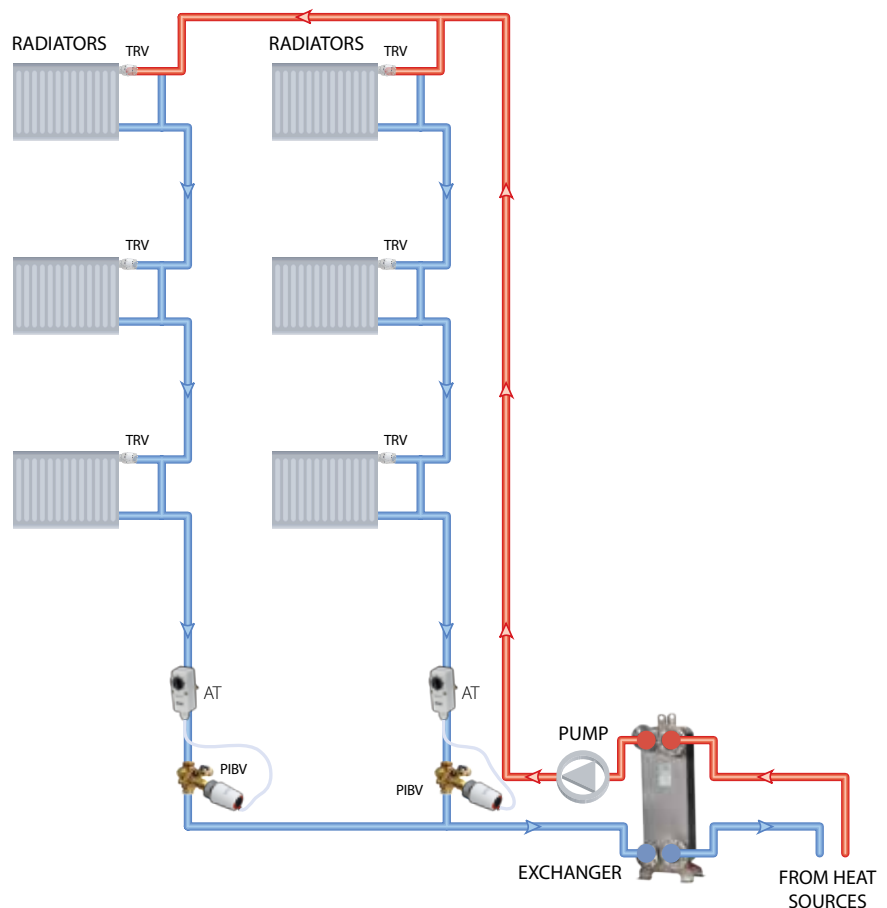

TRV – Thermostatic Radiator Valves  
PIBV – Pressure Independent Balancing Valves (as flow limiter)  
AT – Pipe Thermostat

## SAVINGS

Investment type	AB-QM (AT +TWA)
Investment costs [€]	6144
Av. yearly energy saving [GJ]	235
Energy price (DH) [€/GJ]	8
<b>Pay back time [year]</b>	<b>3,3</b>

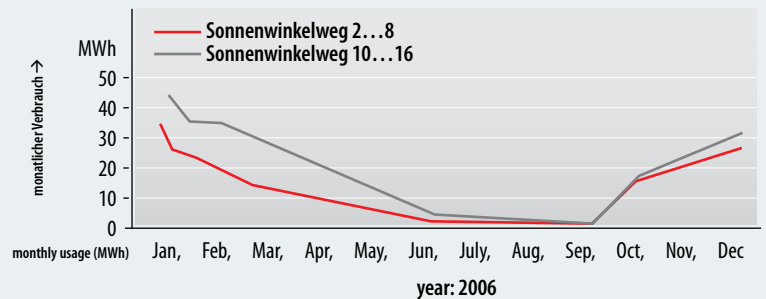

## INVESTMENT COSTS

Equipment	Pcs.	Price [€]	Installation costs [€]	Sum
AB-QM (TWA+AT)	36	5500	644	6144

## ENERGY USAGE AND ENERGY SAVING OF BUILDING

	Energy used in MWh		
	2006	2007	2008
Building 5 with AB-QM and AT str. Sonnenwinkelweg 2-8, Sachsen	171	132	124
Building 6 without str. Sonnenwinkelweg 10-16, Sachsen	211	213	199
difference in MWh	40	81	75
Average yearly energy saving [GJ]	235		

## CONCLUSION

A new concept of one pipe regulation, based on return temperature control, brings an additional 20% saving during one heating operation session. It is very important to note that one pipe heating systems, when used with a by-pass on the radiators, that this automatically means that the radiator thermostat can only close the flow through the radiators. But when the TRV's are closed the water can still circulate through the by-pass at all times. This provides a situation where the return temperature in the bottom of the risers will increase. A thermostat detects a higher return temperature, what allows reducing the flow. (This is not necessary when TRV's are closed). This type of solution makes a one pipe system a very efficient and variable flow system. In the above graph we can see the monthly used energy comparison between the two buildings.



# STRONGLY RECOMMENDED INVESTMENT!

## 3.2

### One-pipe heating system in special shaped medium high residential buildings

Type of building	Name of project	Main data	Picture of building
 Medium high rise building	<b>Building Society "Dąb" Szczecin, Poland</b>	<ul style="list-style-type: none"> <li>Address: str. 26 Kwietnia</li> <li>Three similar buildings</li> <li>Each of buildings have:</li> <li>Number of floors: 9</li> <li>Number of staircases: 5</li> <li>Number of flats: 180</li> <li>Heated space: 31660 m<sup>3</sup></li> <li>Number of radiators: 790</li> <li>Number of risers: 97</li> </ul>	

#### THE PROJECT

The buildings was built in 1976 as a so called "Lenin-grad Building" consisting of concrete panels. The design and all the building elements were prepared in St. Petersburg in Russia. The heating system design, a traditional one pipe system, originally used a three way valve with a shut-off function only. The radiators are cast-iron types. The heat supply of the building comes from a big sub-station which is located about 100 meters from the building and also supplies two other buildings. Renovation was started in 1994-95 with thermostatic radiator valves installation (Danfoss, RTD-D, type) and sub-station renovation (weather compensator, control valves and DP controller were installed). Due to lack of money for hydraulic balance was done based on traditional manual method with measuring orifices. In 1996-97 heat cost allocators were installed which allow measuring individual energy consumption. The next step of renovation was done in 2002-2003: wall isolation (10cm of polystyrene) and new windows. Due to still relatively high energy consumption (compared to a traditional two-pipe system) in 2009 the Building Society was considering to change the heating system to a two-pipe system or use automatic, adjustable flow limiters on the risers with self action thermostats (Danfoss solution: AB-QM + QT). Investment for the second solution was five times less expensive!

#### USED DANFOSS EQUIPMENT FOR RENOVATION

- A | In 1994-95 : Danfoss radiator thermostat were installed DN 15-20 mm ( 483, 307 pcs. in each building), type RTD-D
- B | in 2009 : Danfoss automatic flow limiters with self action thermostat used in risers: AB-QM with QT  
Dimension: DN 15-20 (57,40 pcs. in each building)

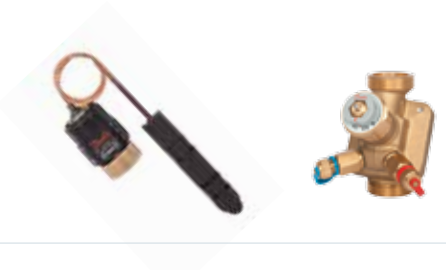
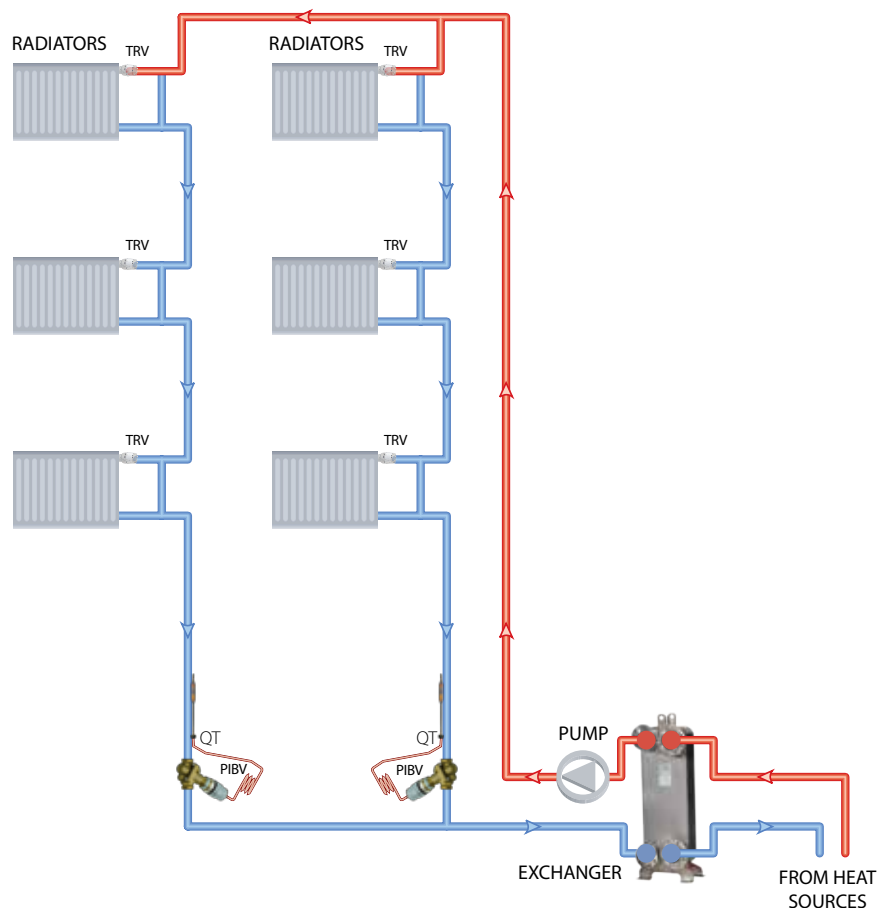

TRV – Thermostatic Radiator Valves  
 PIBV – Pressure Independent Balancing Valves (as flow limiter)  
 QT – Self Acting Thermostat

## SAVINGS

Investment type	AB-QM + QT
Investment costs [€]	32201
Av. energy saving from three heating seasons [GJ]	1283
Energy price (DH) [€/GJ]*	9,7
<b>Pay back time [year]</b>	<b>2,6</b>

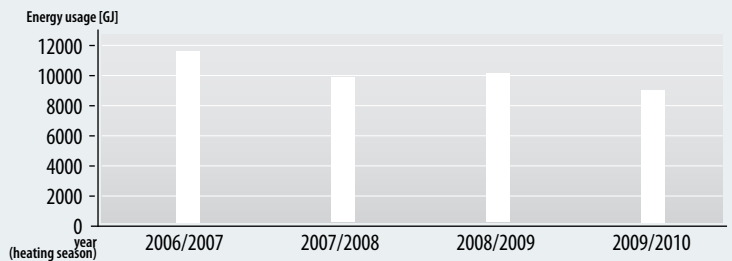

\* as AB-QM and QT were installed in December 2009.

## INVESTMENT COSTS

Equipment	Pcs.	Price [€]	Installation costs [€]	Sum
Automatic flow limiters with selfacting thermostat (AB-QM + QT)	291 (91x3)	27063	5238	32201

## ENERGY USAGE AND ENERGY SAVING OF BUILDING

Year (heating season)	Energy used in heating season (GJ)	Corrected energy used (degree-day method) (GJ)	Average outdoor temperature in heating season (C)	Average energy saving from three heating season in GJ	Action
2006/2007	11355,4	11615,8	6,1		
2007/2008	10403,5	9697,0	3,9		
2008/2009	10795,5	10000,8	3,3		
2009/2010	9876,6	9154,8	2,2	1283	AB-QM + QT installation

## CONCLUSION



This new solution, that controls the flow in the riser depending on the temperature in the pipe, converts a one-pipe system (constant flow system) into a variable flow system. Unnecessary water flow (when TRV's are closed) is reduced to a minimum by self action balancing valves, which were installed in each riser. In spite of AB-QM + QT (thermostat operation) it should be mentioned that AB-QM ensures a proper balance between risers. This is a huge benefit (proved by this case) that due to a correct balance system, there were no complaints about cold risers during a very strong winter period 2009-10! The proposed solution by Danfoss for one pipe heating system based on automatic flow limiters with self action thermostats (AB-QM + QT) should be recommended for all regions and countries where the energy costs are high as it allows achieving huge energy consumption reductions with high indoor quality comfort! Short pay back time (less than 3 years) which was confirmed by this case is excellent evidence for this proper solution offered by Danfoss.



# STRONGLY RECOMMENDED INVESTMENT!

## 3.3

### One-pipe heating system in special shaped medium high buildings

Type of building	Name of project	Main data	Picture of building
 Medium high rise building	<b>Building Society "VIZAFAGÓ 19" Budapest, Hungary</b>	<ul style="list-style-type: none"> <li>• Address: Nepfűrdő u. 19</li> <li>• Number of floors: 10</li> <li>• Number of staircases: 6</li> <li>• Number of flats: 260</li> <li>• Heated space: 40.892 m<sup>3</sup></li> <li>• Number of radiators: 1040</li> <li>• Number of risers: 128</li> </ul>	

#### THE PROJECT

This building was built in 1978 with blocks of flat technology (concrete panels). The heating system is a relatively modern one pipe system – equipped with by-pass – and manual control valves are in front of the radiators. The water distribution is equipped with manual balancing valves originally. The modernisation had not been completed yet. Only the renovation of water distribution was inevitable because of many claims. This renovation was finished in 2002 during the summer maintenance period.

#### USED DANFOSS EQUIPMENT FOR RENOVATION (IN 2002)

ASV-Q flow limiter (predecessor of AB-QM) was installed in all bottom of risers  
 Dimension: DN 15-25 (26, 68, 34 pcs.)

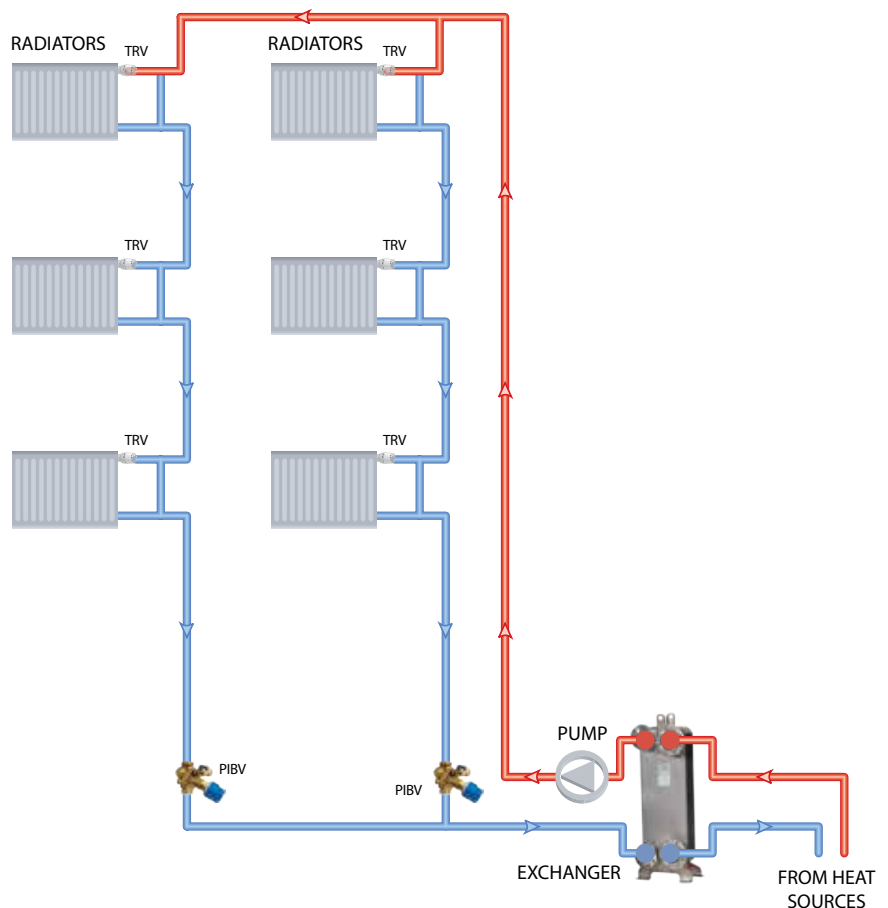

PREVIOUS SOLUTION



CURRENT SOLUTION

TRV – Thermostatic Radiator Valves  
 PIBV – Pressure Independent Balancing Valves (as flow limiter)



## SAVINGS

Investment type	ASV-Q
Investment costs [€]	15030
Av. yearly energy saving [GJ]	1491,5
Energy price (DH) [€/GJ]*	11,99
<b>Pay back time [year]</b>	<b>0,8</b>

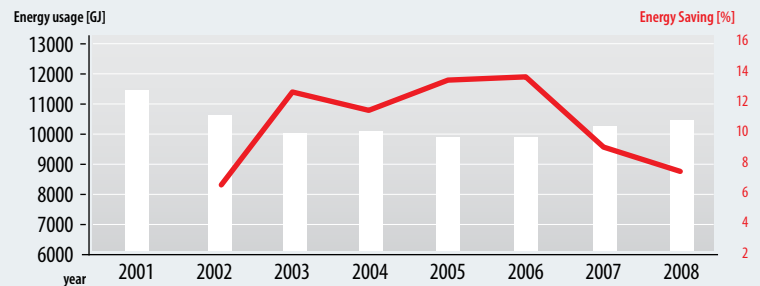

\*This price is based on local DH company price

## INVESTMENT COSTS

Equipment	Pcs.	Price [€]	Installation costs [€]	Sum
Flow limiter	128	13173	1857	15030

## ENERGY USAGE AND ENERGY SAVING OF BUILDING

Year	Energy usage (heating) [GJ]	Corrected energy usage to 3,59°C	Saving in % compared to 2001	Average outdoor temp. [°C]	Average yearly energy saving (GJ)	Action
2001	11486	11486		3,6		
2002	9197	10713	6,7%	4,8		Flow limiter installation in the bottom of riser
2003	11395	10056	12,5%	2,5	1491,53	
2004	9624	10117	11,9%	4,0		
2005	10104	9915	13,7%	3,4		
2006	9619	9889	13,9%	3,8		
2007	8832	10418	9,3%	4,9		New sub-station
2008	9180	10590	7,8%	4,7		

## CONCLUSION

The year of investment is very well visible in the figures above. In 2002 the energy saving is approximately half of the coming years because of the fact that the installation was done in the summer so the energy savings concern half a season only. The energy savings decreased a bit after 2007, due to the implementation of a new individual sub-station for the building. From this year on it was possible to increase the flow temperature to reduce the under heating on the first floors. With individual flow limiters in the bottom of the risers the water deviation became excellent and we could save ~11-13% of energy. The new sub-station helped to increase the level of comfort of flat owners.



# STRONGLY RECOMMENDED INVESTMENT!

## 4.1

### Domestic hot water system in long residential buildings

Type of building	Name of project	Main data	Picture of building
 Long building	<b>Building Society "Wspólny Dom" Szczecin, Poland</b>	<ul style="list-style-type: none"> <li>• Address: Zakole 27-36, Szczecin, Poland</li> <li>• Number of floors: 5</li> <li>• Number of staircases: 10</li> <li>• Number of flats: 73</li> <li>• Number of risers: 40</li> </ul>	

#### THE PROJECT

The renovation of this building started in 1996 with a TRV installation. After that – in several steps – the domestic hot water system reconstruction was realised in 2006. The tendency of the energy saving (in %) is well visible. Originally the water distribution with circulation risers was solved with manual balancing valves, therefore overflow and high return temperature was typical in the system. After renovation the circulation became temperature controlled and energy saving.

#### USED DANFOSS EQUIPMENT FOR RENOVATION (IN 2006)

- A | MTCV return temperature limiter basic version was installed in the bottom of all DHW circulation risers  
Dimension: DN 20 (40 pcs.)

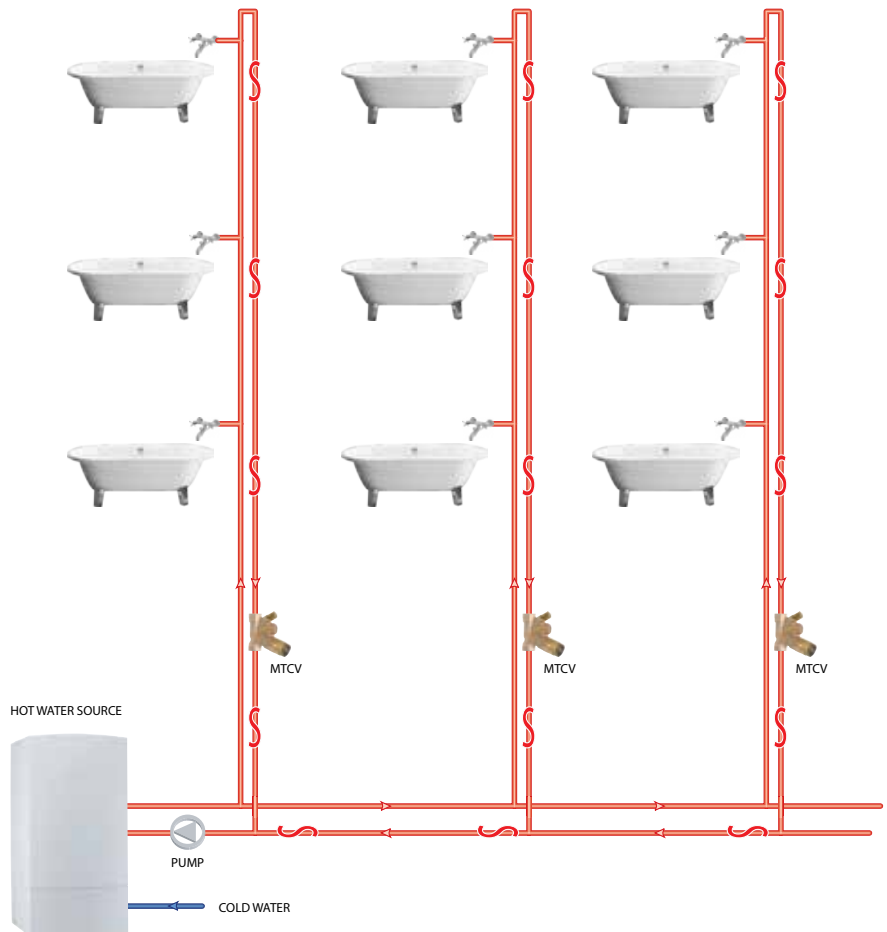

MTCV – Multifunctional Temperature Control Valve

## SAVINGS

Investment type	MTCV
Investment costs [€]	2353
Av. yearly energy saving [GJ]	430,1
Energy price (DH) [€/GJ]*	13,20
<b>Pay back time [year]</b>	<b>0,41</b>

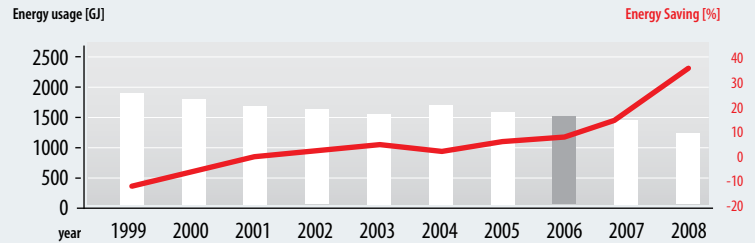

\* This price is based on local DH company price

## INVESTMENT COSTS

Equipment	Pcs.	Price [€]	Installation costs [€]	Sum
MTCV valve into the circulation riser	40	2167	187	2353

## ENERGY USAGE AND ENERGY SAVING OF BUILDING

Year	Energy usage [GJ]	Saving in % compared to average of 1999-2005	Average yearly energy saving (GJ)	Action
1999	1920	-11,9%		More and more owners built in individual water meter
2000	1841	-7,3%		
2001	1728	-0,7%		
2002	1658	3,4%		
2003	1596	7,0%		
2004	1665	3,0%		
2005	1603	6,6%		
2006	1566	8,7%		MTCV installation
2007	1436,8	16,3%	430,1	
2008	1134,4	33,9%		

## CONCLUSION



In the first years (1999-2003) the energy usage decreased continuously due to the fact that more and more owners built in an individual water meter in their own flat. The energy saving had started. The energy usage became stable in the period of 2004-2006. The installation of the MTCV return temperature limiter is well visible, the energy saving increased immediately after the installation. After one year of experience (2007) the set value of return temperature was reduced for further energy savings. Energy saving has increased from 16% to 34%.



# STRONGLY RECOMMENDED INVESTMENT!

## 4.2

### Domestic hot water system in medium long residential buildings

Type of building	Name of project	Main data	Picture of building
 Long building	<b>Building Society "Osiedle Młodych" Poznań, Poland</b>	<ul style="list-style-type: none"> <li>• Address: Tysiaclecia 16-42, 26-29, 33-42</li> <li>• Number of floors: 5</li> <li>• Number of staircases: 10</li> <li>• Number of building: 3</li> <li>• Number of risers: 60</li> </ul>	

#### THE PROJECT

The renovation of this building started in 1994 with a TRV installation. After installation of TRV and heat cost allocators, the domestic hot water system reconstruction was realised in 2003. Originally the water distribution among circulation risers was solved with manual balancing valves therefore overflow and high return temperature was typical in the system. After renovation the circulation became temperature controlled. The elapsed time clearly shows us the energy saving due to renovation.

#### USED DANFOSS EQUIPMENT FOR RENOVATION (IN 2003)

- A | MTCV return temperature limiter basic version was installed in all bottom of DHW circulation risers  
Dimension: DN 20 (60 pcs.)

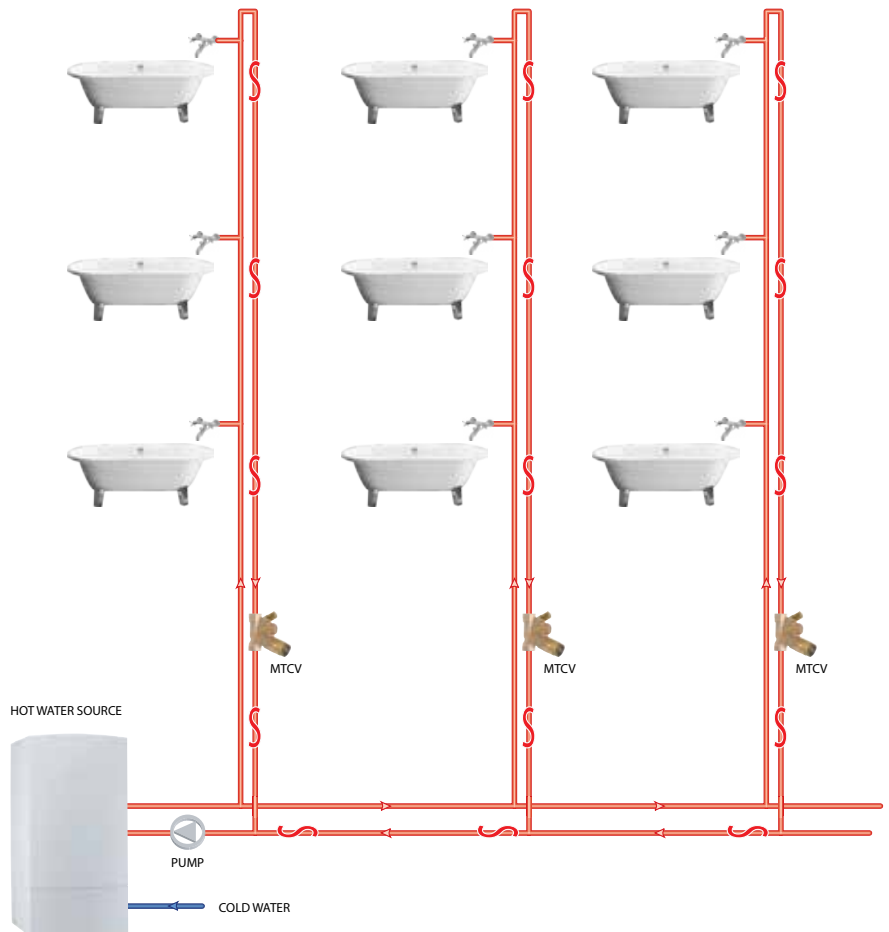

MTCV – Multifunctional Temperature Control Valve

## SAVINGS

Investment type	MTCV
Investment costs [€]	4475
Av. yearly energy saving [GJ]	920,3
Energy price (DH) [€/GJ]	7,77
<b>Pay back time [year]</b>	<b>0,63</b>

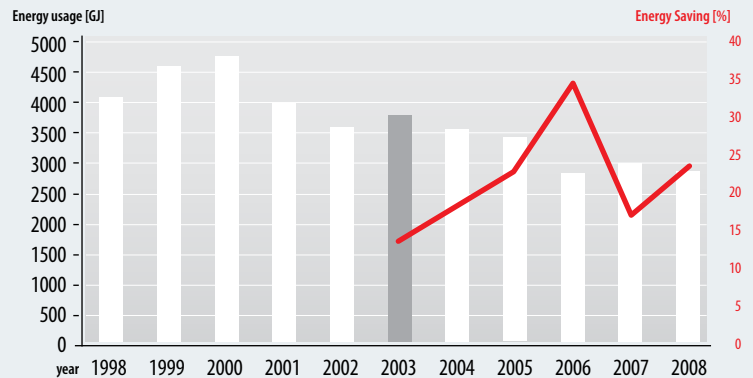

Calculation: period 1998-2002 compared to period 2003

## INVESTMENT COSTS

Equipment	Pcs.	Price [€]	Installation costs [€]	Sum
MTCV valve into the circulation riser	60	3251	1224	4475

## ENERGY USAGE AND ENERGY SAVING OF BUILDING

Year	Energy usage [GJ]	Saving in % compared to average of 1998-2002	Average yearly energy saving (GJ)	Action
1998	4142			
1999	4607			
2000	4689			
2001	3979			
2002	3593			
2003	3788	13,0%		MTCV installation
2004	3554	18,4%		
2005	3342	23,2%		
2006	2833	34,9%	920,3	
2007	3456	20,6%		
2008	3223	26,0%		

## CONCLUSION

In the first years (1998-2000) the energy usage increased than decreased continuously due to the fact that more and more owners built in an individual water meter in their own flat. The energy saving had started. The energy usage more or less stabilised in the period of 2002-2003. The installation of the MTCV return temperature limiter is well visible, the energy saving increased immediately after the installation. After two years of experience (2006) the set value of return temperature was reduced for further energy savings. Energy saving has increased from 18% to 35%.



# STRONGLY RECOMMENDED INVESTMENT!

## 4.3

### Domestic hot water system in high residential buildings

Type of building

Name of project

Main data

Picture of building



High building

**Building Society  
"Osiedle Młodych"  
Poznań, Poland**

- Address: Tysiąclecia 70
- Number of floors: 16
- Number of staircases: 2
- Number of flats: 128
- Number of risers: 15



#### THE PROJECT

In 1994 the building was renovated with a TRV installation. After that – in several steps – the domestic hot water system reconstruction was realised in 2003. Originally the water distribution among circulation risers was solved with manual balancing valves therefore overflow and high return temperature was typical in the system. After renovation the circulation became temperature controlled. The elapsed time clearly shows us the energy saving due to renovation.

#### USED DANFOSS EQUIPMENT FOR RENOVATION (IN 2003)

- A | MTCV return temperature limiter basic version was installed in all bottom of DHW circulation risers  
Dimension: DN 20 (15 pcs.)

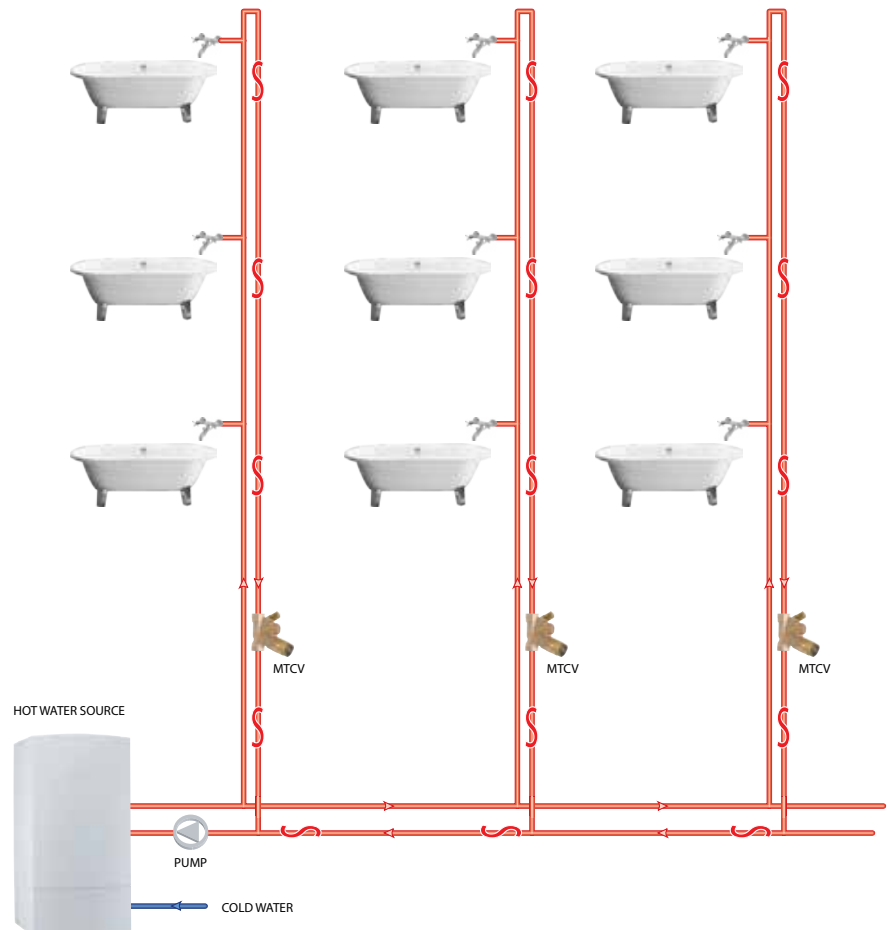

MTCV – Multifunctional Temperature Control Valve

## SAVINGS

Investment type	MTCV
Investment costs [€]	1119
Av. yearly energy saving [GJ]	292,4
Energy price (DH) [€/GJ]	8,79
<b>Pay back time [year]</b>	<b>0,44</b>

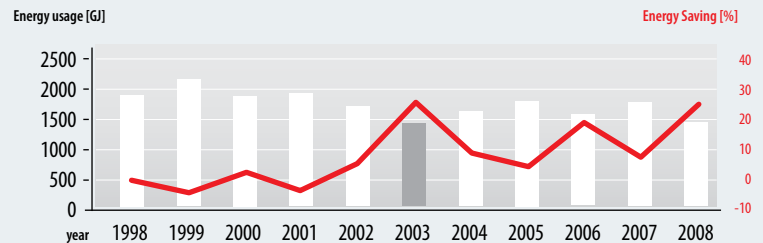

Calculation: period 1998-2002 compared to period 2004-2008

## INVESTMENT COSTS

Equipment	Pcs.	Price [€]	Installation costs [€]	Sum
MTCV valve into the circulation riser	15	813	306	1119

## ENERGY USAGE AND ENERGY SAVING OF BUILDING

Year	Energy usage for DHW [GJ]	Saving in % compared to average of 1998-2002	Average yearly energy saving (GJ)	Action
1998	1915	-0,3%		
1999	2035	-6,6%		
2000	1855	2,8%		
2001	1956	-2,4%		
2002	1785	6,5%		
2003	1416	25,8%		MTCV installation
2004	1722	9,8%	292,4	
2005	1809	5,3%		
2006	1568	17,9%		
2007	1746	8,6%		
2008	1440	24,6%		

## CONCLUSION

In the years (1998-2002) the energy usage was varying in a narrow range, but we can see that the average consumption was on a high level. The year of the installation of the MTCV return temperature limiter is well visible (2003). The energy saving has increased suddenly. From this year on the energy usage is still fluctuating (most probably based on hot water usage behaviour) but on a significantly lower level. The average yearly energy saving is not visible but close to a 300 GJ.



In these types of high buildings where the distribution pipeline is not very long, the energy saving potential is smaller (although this effect is compensated by length of vertical pipeline) but in the same time the investment costs are limited. All in all we achieved a pay back time of less than 6 months. This is an excellent achievement!



# STRONGLY RECOMMENDED INVESTMENT!

## 5.1

### Cooling system comparison in special shaped office buildings

Type of building	Name of project	Main data	Picture of building
 special shaped office building	<b>Office center "V Parku"</b> <b>Prague, Czech Republic</b>	<ul style="list-style-type: none"> <li>• Address: Prague-Chodov,</li> <li>• Number of terminal units: 305</li> <li>• Heated space: 31376 m<sup>3</sup></li> <li>• Number of floors: 4</li> <li>• Type of balancing: <i>Building 1):</i> Manual balancing and MCV at TU <i>Building 2):</i> PIBCV at all TU</li> </ul>	

#### THE PROJECT

The Office Park project started in 2004. The first six buildings were built with traditional constant flow heating/cooling system technology. This means that the fan-coils are controlled by a 3-way motorised control valve with ON/OFF control and the AHUs 0-10V modulation control. The water deviation was ensured with manual balancing valves. The system commissioning has been done by an independent company. In 2007 Danfoss offered new PIBCV technology and the investor had made the decision that the remaining 12 buildings were equipped with AB-QM valves. The energy efficiency of different heating/cooling systems can be compared easily, because the physical conditions and the usage of the buildings are similar.

#### USED DANFOSS EQUIPMENT FOR RENOVATION (IN 2007)

**A** | AB-QM pressure independent balancing motorised flow limiter for fan-coils  
Dimension: DN 15-25 (300 pcs.)



**B** | AB-QM pressure independent balancing control valve for air handling units  
Dimension: DN 40-65 (5 pcs.)

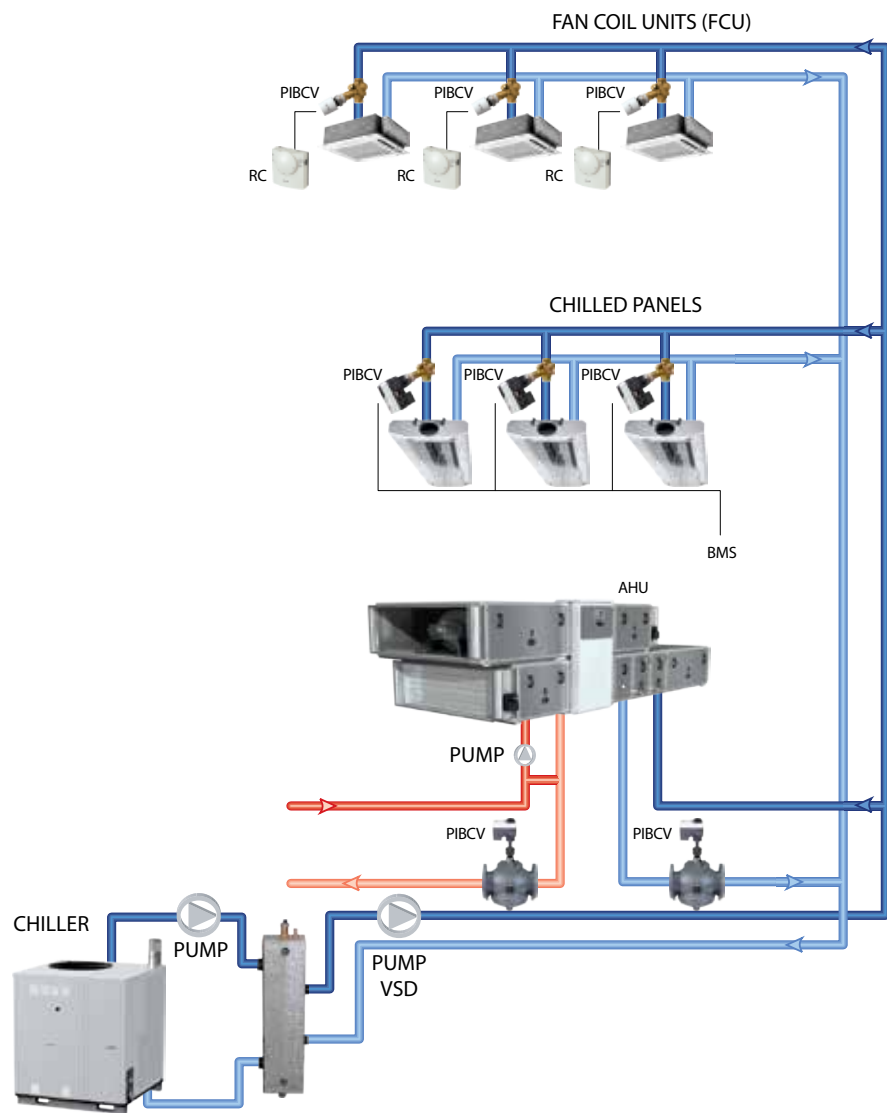

PIBCV – Pressure Independent Balancing Control Valves  
RC – Room Controller  
BMS – Building Management System  
VSD – Variable Speed Drive



## SAVINGS

Investment type	Traditional	AB-QM renovation	AB-QM investment
Investment costs [€]	24582	27937	3355
Av. yearly energy saving [GJ]	-	48924	48924
Energy price (DH) [€/GJ]	9,12	9,12	9,12
<b>Pay back time [year]</b>		<b>5,2</b>	<b>0,6</b>

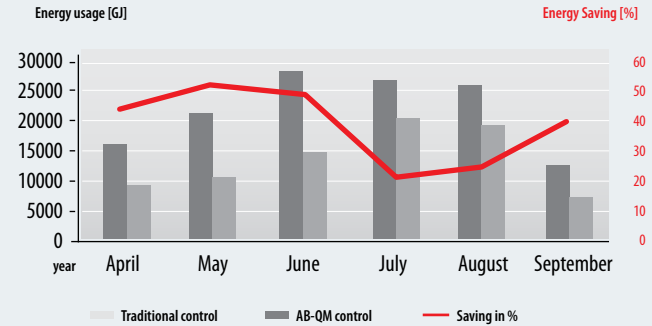

\*This price is based on local DH company price

## INVESTMENT COSTS

Equipment	Pcs.	Price [€]	Installation costs [€]	Sum
Traditional control in front of terminal units and MBV	305	22292	2290	24582
AB-QM in front of terminal	305	26372	1565	27937

## USAGE AND ENERGY SAVING OF BUILDING IN 2007 SUMMER

Year 2007	Energy usage (cooling) with traditional control [GJ]	Energy usage (cooling) with AB-QM control [GJ]	Saving in %
April	16 585	9 487	42,8%
May	21 569	10 424	51,7%
June	28 353	14 526	48,8%
July	26 009	20 366	21,7%
August	25 396	19 191	24,4%
September	12 607	7 601	39,7%
<b>Sum</b>	<b>130 519</b>	<b>81 595</b>	<b>38,2%</b>

## CONCLUSION

The figures above show that with the usage of AB-QM flow limiters/controllers we can save close to 40% of energy on an average level compared to a traditional constant flow system. From an investment point of view the installation costs difference between a traditional and an AB-QM system is insignificant (13%), the pay back time is 0,6 year. In case of renovation with the replacement of the original valves we can't expect such good pay back time.



The pay back time in this project is 5,2 years. Particularly if we take into consideration the better comfort with AB-QM valves. This is a good investment.



# STRONGLY RECOMMENDED INVESTMENT!

## 5.2

### Cooling and heating system in medium high office building

Type of building	Name of project	Main data	Picture of building
 special shaped medium high building	<b>Office center "Bakats Center" Budapest, Hungary</b>	<ul style="list-style-type: none"> <li>• Address: Ráday u. 51</li> <li>• Type of system: four pipe heating / cooling system</li> <li>• Number of terminal units: 112 pcs., 56 pcs. in heating and 56 pcs. cooling</li> <li>• Heated/cooled space: 4310 m<sup>3</sup></li> <li>• Number of floors: 7</li> <li>• Type of balancing: <i>Originally: Manual balancing and zone valve at FC</i> <i>Reconstruction: PIBCV at FC</i></li> </ul>	

#### THE PROJECT

The Office building was built in 2002. The heating-cooling system is a four pipe variable flow system. The terminal unit is equipped with ON/OFF control by room thermostats via thermo hydraulic actuator. The hydraulic balancing was solved with manual valves. Due to high energy bill and unsatisfied users the owner of the building has done a study regarding renovation possibilities in 2007. The study pointed out that the reason of problems came from insufficient balancing mainly. Consequently the owner decided that they change the manual balancing valve to automatic flow limiter (AB-QM). In this project the thermal actuators remain the original because they fit to AB-QM valve with adapter. The AHU system was not renovated either. The installation of new valves was done in 2008.

#### USED DANFOSS EQUIPMENT FOR RENOVATION (IN 2008)

A | AB-QM pressure independent balancing motorised flow limiter for fan-coils  
Dimension: DN 10-20 (56 -56 pcs.)

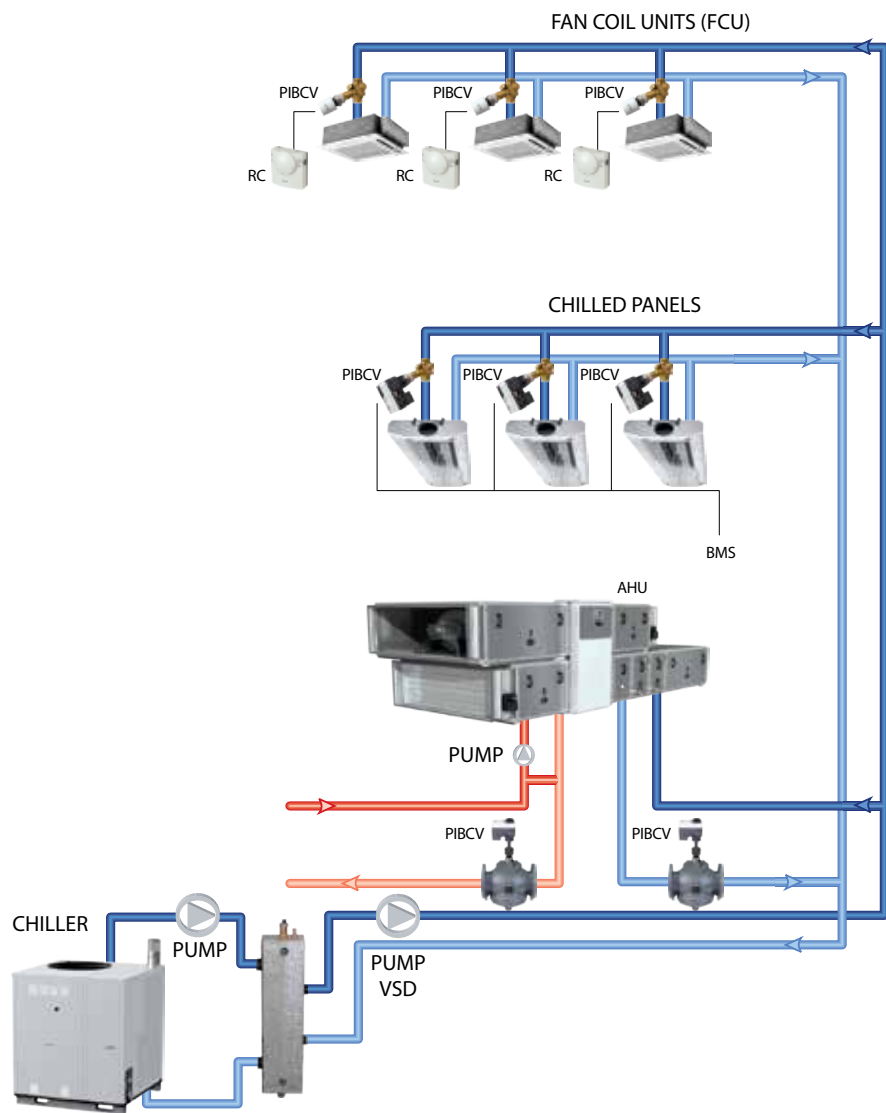

PIBCV – Pressure Independent Balancing Control Valves (as a flow limiter)  
RC – Room Controller  
BMS – Building Management System  
VSD – Variable Speed Drive

## SAVINGS

Investment type	AB-QM renovation	
	Heating*	Cooling
Investment costs [€]	3933	5199
Av. yearly energy saving [GJ] / [kWh]	183,8	40858
Energy price (gaz) [€/GJ] / [€/kWh]	5,53	0,184
<b>Pay back time [year]</b>	<b>3,9</b>	<b>0,7</b>

Energy usage – Heating [GJ]

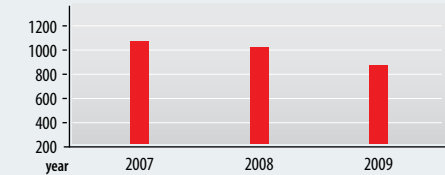

Energy usage – Cooling [kWh]

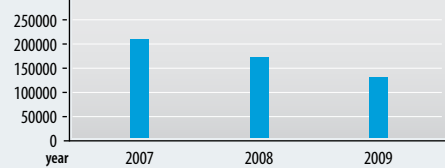

\*The real pay back time of heating is better due to the renovation in 2008

## INVESTMENT COSTS

Equipment	Pcs.	Price [€]	Installation costs [€]	Sum
AB-QM valves for heating	56	3411	522	3933
AB-QM valves for cooling	56	4639	560	5199

## USAGE AND ENERGY SAVING OF BUILDING

Year	Energy usage – Heating [GJ]				Energy usage – Cooling [kWh]		Action
	Energy usage	Corrected energy usage to 4,87 °C	Average outdoor temp. [°C]	Average yearly energy saving [GJ]	Energy usage	Average yearly energy saving [kWh]	
2007	1120,0	1120,0	4,9		211 429		
2008	1105,0	1076,2	4,7	43,8	193 545	17 884	AB-QM installation
2009	903,0	796,1	3,9	323,9	147 598	63 831	
Average				183,8		40 858	

\* The energy usage of heating contains all gas based energy consumption including domestic hot water. Due to the above mentioned period the water distribution system was modernised only, resulting in energy saving.

\*\*The energy usage of cooling contains all electricity consumption including lightning, lift etc. Due to the above mentioned period the water distribution system was modernised only, resulting in energy saving.

## CONCLUSION



The figures above show that we can save a significant amount of energy with usage of AB-QM balancing/control valve compared to traditional (manual balancing) control method. We can not tell the energy saving in percentage but the average yearly energy saving is well visible. It is more than 200 GJ in heating system based on gas usage reduction and 40 thousand kWh in cooling system based on electricity consumption reduction. From an investment point of view the installation cost is not high only the AB-QM valve itself and installation has cost money. The pay back time is acceptable 3,9 years in heating and excellent in cooling 0,7 year furthermore we can ensure much better comfort for users. Since implementation of AB-QM valves we did not face any claims problem due to bad water distribution.



# STRONGLY RECOMMENDED INVESTMENT!

## 5.3

### AHU pumping cost comparison in commercial buildings (cooling application)

Type of building	Name of project	Main data	Picture of building
 special shaped middle high building	<b>Tampines Mall Singapore</b>	<ul style="list-style-type: none"> <li>Address: Tampines Central 5</li> <li>Air Handling Unit application:               <ul style="list-style-type: none"> <li>Measurement 1): AHU is equipped with traditional control element (manual balancing valves and MCV) as a constant flow system</li> <li>Measurement 2): AHU is equipped with PIBCV as a variable flow system</li> </ul> </li> </ul>	

#### THE PROJECT

The selected building is a shopping mall. The main purpose of measurement is to prove the energy efficiency of PIBCV control in variable flow system to be compared with traditional control in constant flow system (typical application). In the first step we have measured a selected AHU namely the flow and return temperatures furthermore the blow in and room temperatures. We have done the same measurement on the same AHU after renovation (installation of AB-QM valve).

The AHU control was arranged by 0-10V proportional controller.

For measurement we have chosen equal circumstances like usage of space and external weather conditions.

#### USED DANFOSS EQUIPMENT FOR NEW BUILDING (IN YEAR 2008)

- A | AB-QM pressure independent balancing control valve for air handling units  
Dimension: DN 50 (1 pcs.)  
The calculation on the following page refers to AHU only

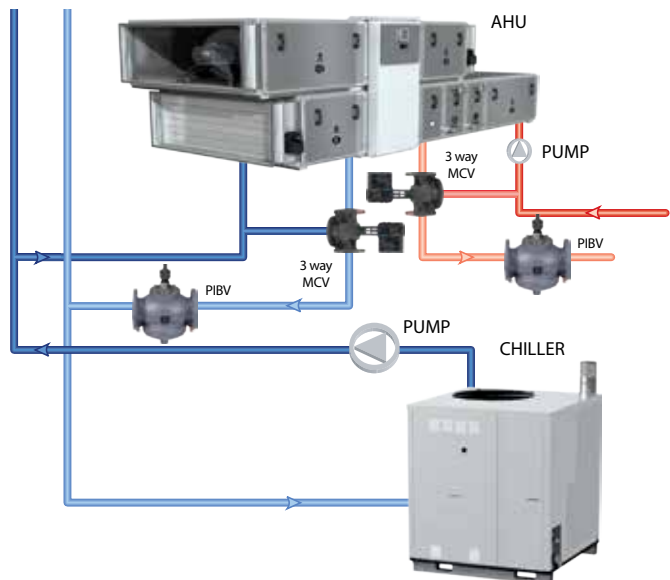

MCV – Motorised Control Valves  
PIBV – Pressure Independent Balancing Valves (as a flow limiter)  
AHU – Air Handling Unit

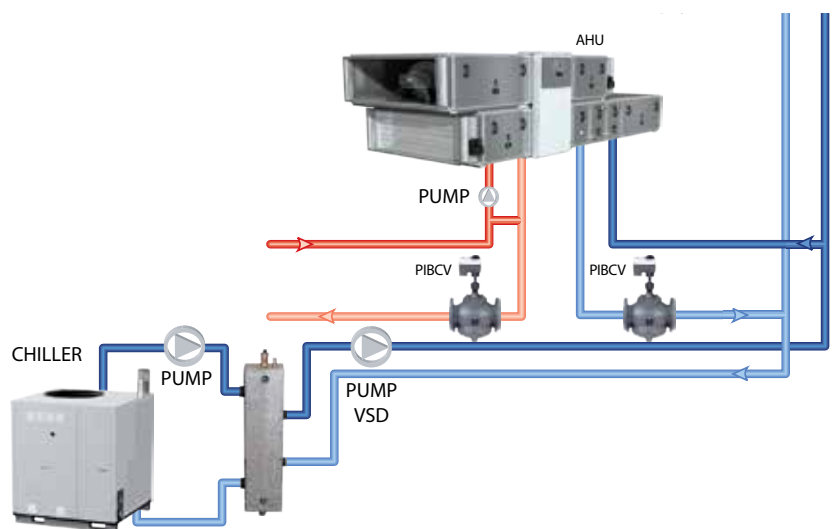

PIBCV – Pressure Independent Balancing Control Valve  
AHU – Air Handling Unit

## SAVINGS

Investment type	Traditional	AB-QM renovation
Investment costs [€]	–	1127
Yearly circulation cost [kWh/AHU]*	7.296	3.356
Av. yearly energy saving [GJ] / [kWh]	–	3.940
Energy price (gaz) [€/GJ] / [€/kWh]	0,084	0,084
<b>Pay back time [year]</b>		<b>3,4</b>

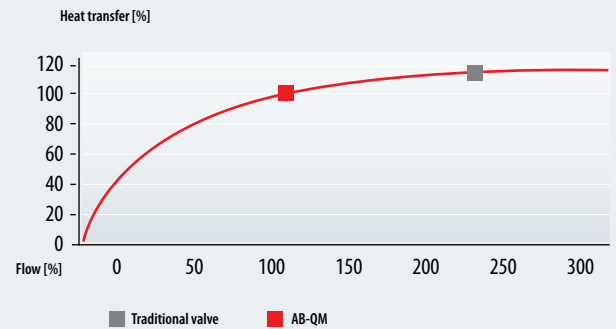

\* Length of season: 330 days, working hours: 16 hour/day

## INVESTMENT COSTS

Equipment	Pcs.	Price [€]	Installation costs [€]	Sum
AB-QM installation	1	1004	123	1127

## CIRCULATED FLOW CALCULATION BASED ON COOLING CAPACITY AND TEMPERATURE DROP ON AHU IN DIFFERENT APPLICATIONS

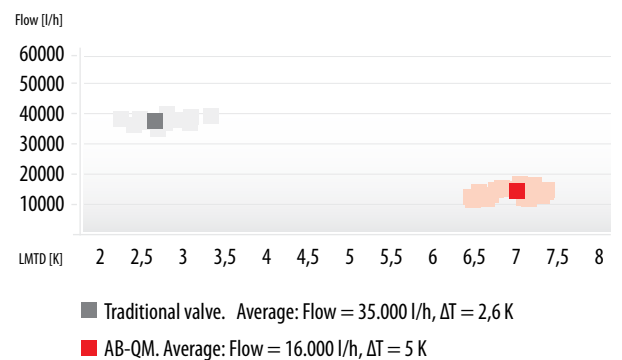
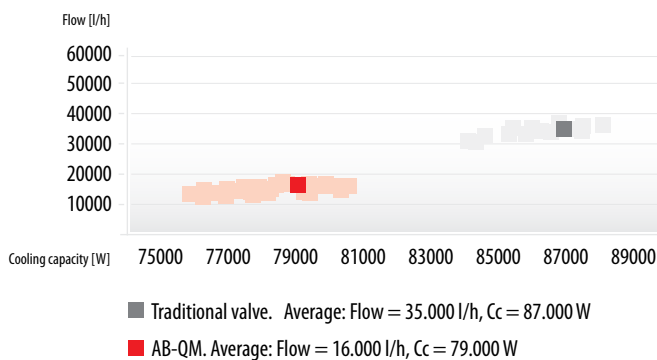

## CONCLUSION



From the diagram above is well visible that the constant flow system requires continuous nominal flow independent of the real demand. In case of usage of AB-QM the expected seasonal average flow is less than half of the nominal flow. This brings us significant energy saving potential. The pumping power demand is 54% less. With other words we can say that the cost of circulation is 46% compared to traditional solution. From an investment point of view the pay back time gives the opportunity to make a decision. It is in our case 3,4 years, this results in a very good investment. Particularly if we take into consideration the increasing energy efficiency of chiller and increased comfort with AB-QM valves.



# STRONGLY RECOMMENDED LONG TERM INVESTMENT!

## 6.1

### Energy saving in macro scale

Type of building	Name of project	Main data	Picture of building
 <p>a lot of different buildings</p>	<p><b>Building Society „Wspólny Dom”, Szczecin, Poland</b></p>	<ul style="list-style-type: none"> <li>• Number of buildings: 149 multifamily and 199 single family houses</li> <li>• 61 pcs. high – 12 stories – buildings</li> <li>• 88 pcs. small – 5 stories – buildings</li> <li>• Number of flats: 12.000</li> <li>• Heated surface: 600.000 m<sup>2</sup></li> <li>• Number of tenants: 31.000</li> </ul>	

#### SYSTEM DESCRIPTION BEFORE RENOVATION:

- Original wall construction and traditional windows are used according temporarily standard
- Heating: two-pipe heating system with manual valve and hand wheel on radiators furthermore manual balancing valves in risers. Temperature regime 90/70°C, supplied from district heating sub-station.
- Domestic hot water (DHW) (90% of building is equipped): circulation pipeline with manual water distribution. The set temperature is 55°C.

#### SYSTEM DESCRIPTION AFTER RENOVATION:

- Thermal insulation of wall, roof and basement according new norm
- All radiators equipped with thermostatic radiator valve and heat cost allocator
- The hydraulic balancing is optimised by automatic (pressure differential) riser controller
- The DHW circulation system was modernised with a thermal balancing valve.

#### THE PROJECT

93% of the buildings were built before 1992. The modernisation of the buildings started in 1995 and was finalised in 2005. During this 10 year period, 418.052 m<sup>2</sup> wall and half of the building's roof surface was insulated and 10.700 windows were exchanged. In the same time the heating and DHW system were modernised with TRVs, automatic balancing valves in heating pipelines and thermal balancing valves in the DHW circulation.

To save energy for the tenants, individual radiators were equipped with heat cost allocators. This project included modernisation of 128 sub-stations, also split of 3 big central sub-stations into 15 smaller ones and exchanged weather compensators. The modernisation was performed successively building by building: financial resources allowed executing modernisation of 8 to 14 buildings every year, including all elements mentioned above.

The modernisation program resulted in a reduced 'power order' for the building society from their District Heating Company:

- reduction of 43% for their heating system. From 51 MW in 1995 to 29 MW in 2005.
- reduction of 72% for their water system. From 28 MW in 1995 to 8 MW in 2005.

These savings also influence the total energy expenses, since the District Heating Company charge to end-users.

**A** | Thermostatic radiator valves for each radiator: RTD-N + thermo head RTD  
Dimension: DN 10-15-20 (37.000 pcs.)



**B** | Differential pressure controller pair in the bottom of the heating risers: ASV-PV + ASV-M  
Dimension: DN 15-32 (9.300 pcs. Danfoss and 530 other)

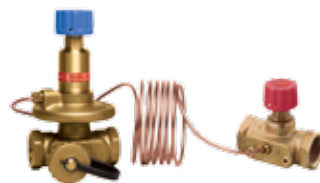

**C** | MTCV return temperature limiter basic version was installed in all bottom of DHW circulation risers  
Dimension: DN 15-20 (3.000 pcs.)



## SAVINGS

	Heating [GJ]	Hot water [GJ]		Heating [MW]	Hot water [MW]
Energy consumption in 1995	436778	259842	Power order in 1995	51	28
Energy consumption in 2005	180586	124499	Power order in 2005	29	8
<b>Reduction [%]</b>	<b>59%</b>	<b>52%</b>		<b>43%</b>	<b>72%</b>

**ESTIMATED  
PAY BACK TIME  
FOR ALL  
INVESTMENTS  
3,8 YEARS**

**"Power order" from District Heating Company in MW for heating and hot water**

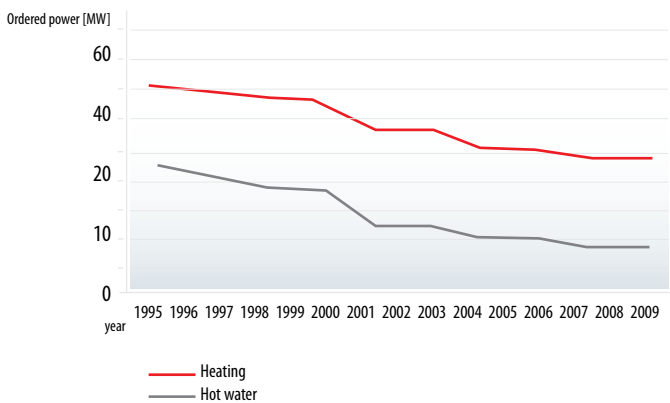

**Energy consumption for heating and hot water system**

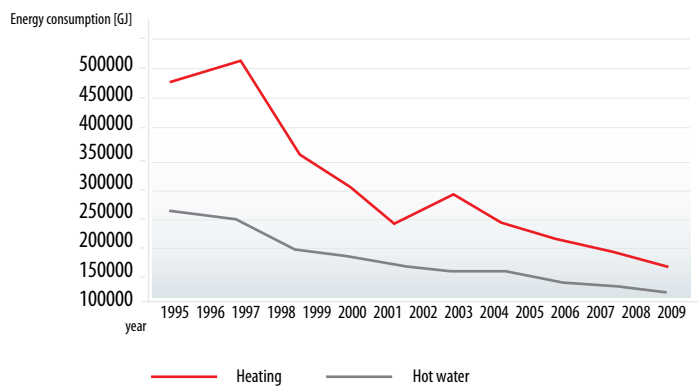

**Energy prices in Poland in EU/GJ**

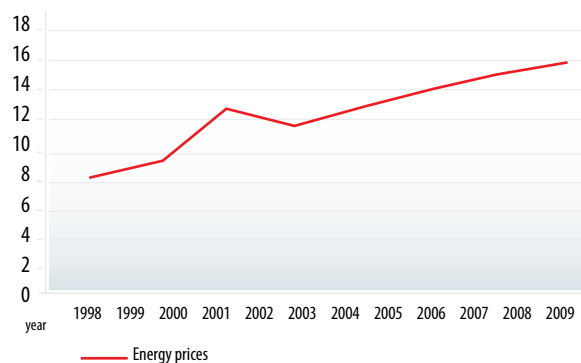

## CONCLUSION

All Building Society's expenses for the heating system were reduced from 12.415.487 PLN in 1998 to 10.625.818 PLN in 2005.

- today Building Society pay 15% less than in 1998, despite of the fact that energy prices increased in this period with 52%.

All Building Society's expenses for the hot water system was reduced from 6.629.081 PLN in 1998 to 4.944.740 PLN in 2005.

- today Building Society pay 24% less than in 1998, despite of the fact that the energy prices increased in this period with 52%



With a reliable and competent supplier like Danfoss excellent results of saving energy, and thus money, can be achieved. The estimated pay back time for all these investments is 3,8 years.



# STRONGLY RECOMMENDED LONG TERM INVESTMENT!

## 6.2

### Energy saving in macro scale

Type of building	Name of project	Main data	Picture of building
 <p>a lot of different buildings</p>	<p><b>Building Society „Osiedle Młodych”, Poznań, Poland</b></p>	<ul style="list-style-type: none"> <li>• Number of buildings: 290 buildings</li> <li>• 37 pcs. – 16 stories – buildings</li> <li>• 35 pcs. – 12 stories – buildings</li> <li>• 218 pcs. – 5 stories – buildings</li> <li>• Number of flats: 30 957</li> <li>• Heated surface: 1 683 214 m<sup>2</sup></li> <li>• Number of tenants: 90.000</li> </ul>	

#### SYSTEM DESCRIPTION BEFORE RENOVATION

- Original wall construction and traditional windows are used according temporarily standard.
- Heating: two-pipe heating system with manual valve and hand wheel on radiators furthermore manual balancing valves in risers.

Temperature regime 90/70°C, supplied from district heating sub-station.

- Domestic hot water (DHW) (90% of building is equipped): circulation pipeline with manual water distribution. The set temperature is 55°C.

#### SYSTEM DESCRIPTION AFTER RENOVATION

- Thermal insulation of wall, roof and basement according new norm.
- All radiators equipped with thermostatic radiator valve and heat cost allocator.
- The hydraulic balancing is optimised by automatic (pressure differential) riser controller.
- The DHW circulation system was modernised with a thermal balancing valve.

#### THE PROJECT

- Osiedle Młodych” Housing Cooperative (HC) in Poznan was founded in 1958.
- The Cooperative has started erecting residential buildings in the Rataje district in 1966.
- Before 1994 all buildings in the Rataje district (excluding „Stare Żegrze” and „Polan” Housing Estates) were built from pre-fabricated elements produced by the local Rataje plant.
- In 1983 – 1991 “Stare Żegrze” and “Polan” Housing Estates buildings were constructed from the pre-cast concrete slabs – Szczecin technology.

- More than 60% of the buildings were erected in the time when the thermal conductivity for walls was equal to 1,16 W/m<sup>2</sup>, and that for flat roofs – 0,87 W/m<sup>2</sup>.
- Today insulation materials for walls and flat roofs are designed with a thermal conductivity below 0,25 W/m<sup>2</sup>.
- The first thermo-modernisation works was carried out in 1987-1995 and included:
- Insulation of external walls, within the framework of the technological shortcomings elimination program. During the first years of this program it was financed by the State by credit remittal and then later by subsidies.
- At the same time 303 in-house heating distribution centres were equipped with meters. Also hot water supply sub-meters, to divide heating energy costs for central heating and hot water supply, were installed. These moderations were mainly financed out of subsidies. Installation of flat water meters was performed intensively at the same time.
- The second step of modernisation of the buildings started in 1996 and was finalised in 2005. In this 10 years period 760 000 m<sup>2</sup> wall and half of the building’s roof surface was insulated and 65000 windows were exchanged. In the same time the heating and DHW system was modernised with TRVs, automatic balancing valves in the heating pipeline and a thermal balancing valve in DHW circulation.

For motivation of tenant’s energy saving the radiators were equipped with heat cost allocators. This project included modernisation of 303 sub-stations also weather compensators and heat meters. The modernisation was performed building by building.

- By the end of 2007 the Cooperative installed more than 84.000 individual flat water meters (for hot and cold water).

**A** | Thermostatic radiator valves for each radiator were installed.  
Danfoss: RTD-N + thermo head RTD  
Dimension: DN 10-15-20 (120.000 pcs.)



**B** | Differential pressure controller pair in the bottom of the heating risers: ASV-PV + ASV-M Dimension: DN 15-32 (7.000 cs. Danfoss)

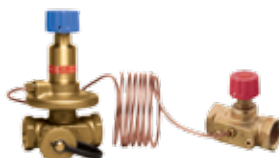

**C** | MTCV return temperature limiter basic version was installed in all bottom of DHW circulation risers Dimension: DN 15-20 (4.000 pcs.)





## SAVINGS

	Heating [GJ]		Heating & Hot water [MW]
Energy consumption in 1998	746,1	Order power in 1997	200,7
Energy consumption in 2007	506,9	Order power in 2008	119
<b>Reduction [%]</b>	<b>32%</b>		<b>41%</b>

ENERGY USAGE  
FOR HOT WATER  
SYSTEM IN THAT  
TIME WAS  
**REDUCED WITH 49%**

## ENERGY USAGE AND ENERGY SAVING OF BUILDINGS

**Heat consumption for central system, in thousand GJ**  
Decrease about 32% from 1998 to 2007

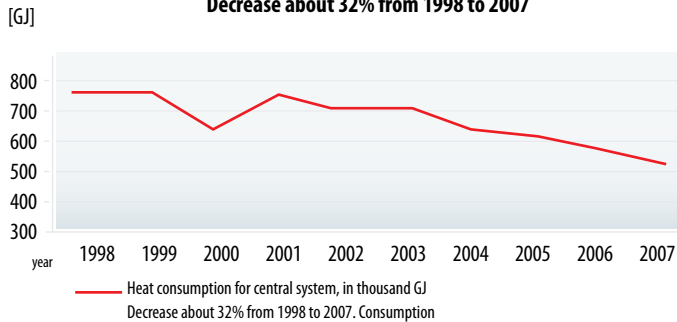

**Energy used for Central Heating and Hot Water Supply**  
in 1997-2008, MW. Decrease by about 40%

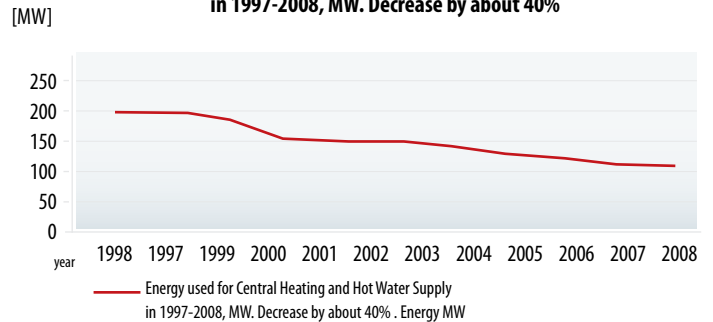

**Energy prices EU/GJ (bruto)**

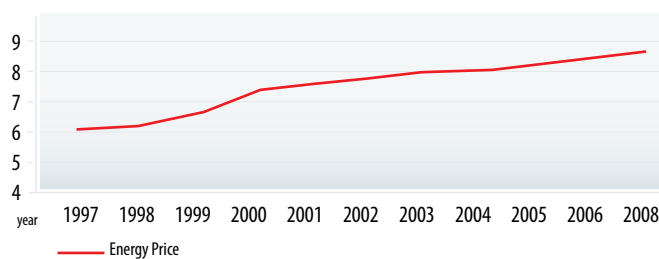

## CONCLUSION

With a reliable and competent supplier like Danfoss excellent results of saving energy, and thus money, can be achieved.



- The calculations show that with 1,66 mln m<sup>2</sup> of the HC heated area and no investment of thermo-modernisation the annual central heating costs could be 42,4mln PLN based on government prices in 1997. The subsidies would then cover the difference with real costs.
- Considering a 50% increase in heating energy costs and the same rise of tenants' payments, the annual central heating costs could be 63,6mln PLN in 2008.
- The real annual central heating costs, considering the current prices and heat consumption at the previous year, is only about 29,5 mln PLN.
- Thus the above 33 mln PLN savings of the central heating costs resulted from the changes in heating energy system and conducted thermo-modernisation works.



# STRONGLY RECOMMENDED INVESTMENT!

## 6.3

### Energy saving in macro scale

Type of building	Name of project	Main data	Picture of building
 <p>a lot of different buildings high building</p>	<b>Thermo-modernisation of Warsaw Housing Cooperative (WHC), Warsaw</b>	<ul style="list-style-type: none"> <li>• Number of buildings: 397 multifamily buildings Including tall buildings 40% – 12 stories and 60% of 5 stories buildings.</li> <li>• Number of flats: 26374 flats</li> <li>• Heated surface: 1.197.000 m<sup>2</sup></li> <li>• Number of tenants: 100.000</li> </ul>	

#### SYSTEM DESCRIPTION BEFORE RENOVATION

- Original wall construction and traditional windows are used according temporarily standard.
- Heating: two-pipe heating system with manual valve and hand wheel on radiators furthermore manual balancing valves in risers. Temperature regime 90/70°C, supplied from district heating sub-station.
- Domestic hot water (DHW)(90% of building is equipped): circulation pipeline with manual water distribution. The set temperature is 55°C.

#### SYSTEM DESCRIPTION RENOVATION

- Thermal insulation of wall, roof and basement according new norm
- All radiators equipped with thermostatic radiator valve and heat cost allocator
- The hydraulic balancing is optimised by automatic (pressure differential) riser controller
- The DHW circulation system was modernised with a thermal balancing valve.

#### THE PROJECT

- Warsaw Housing Cooperative (WHC) was founded on December 11, 1921
- From 1996 installation of Danfoss valves and thermostatic sensors have been successively started.

- Heat meters and heat cost allocators were installed to charge tenants individually.
- In 1999 thermo-modernisation process of WHC assets, including house insulation, replacement of windows, insulation of attic roofs as well as modernisation or changing of central heating and hot water supply systems, has been started.
- Until 2007 around 100 000 balancing valves and thermostatic sensors, 300 ASV-I/ASV-PV balancing valves, 600 USV-I/USV-M valves and around 1500 MTCV valves were installed on hot water supply systems.
- By 2007 thermo-modernisation of 333 houses, built before 1995, was finished.
- In 2003-2007 – 250 houses in total were modernised. The costs are estimated to be 100.000.000 PLN (25 Million Euro).
- The scope of the thermo-modernisation processes in WHC is: installation of two-pipe central heating systems in houses, installation of balancing valves and thermostatic sensors, installation of heat cost allocators, modernisation of local heating distribution systems – SPEC (Enterprise of Heating Energy in Warsaw), insulation of external walls by polystyrene sheets of 10 cm thickness, roof insulation, installation of balancing valves on hot water and central heating risers, changing of windows on staircases and in basements, insulation moderations were performed simultaneously with central heating system modernisation.

#### USED DANFOSS EQUIPMENT FOR HEATING AND DHW RENOVATION (1996 -2005 CONTINUOUSLY)

**A** | Thermostatic radiator valves for each radiator: RTD-N + thermo head RTD  
Dimension: DN 10-15-20 (100.000 pcs.)



**B** | Differential pressure controller pair in the bottom of the heating risers: USV-I/M and ASV-PV and ASV-I  
Dimension: DN 15-32 (900 pcs. Danfoss)



**C** | MTCV return temperature limiter basic version was installed in all bottom of DHW circulation risers  
Dimension: DN 15-20 (1.500 pcs.)



## SAVINGS

	Heating [GJ]	Hot water [GJ]
Energy consumption in 2000	601455,4	254022
Energy consumption in 2009	326746	168766
<b>Reduction [%]</b>	<b>46%</b>	<b>34%</b>

HEATING COSTS  
DECREASED AROUND 22%  
ENERGY PRICES  
INCREASED 18%

Based on given facts we can see the following results:

Heating costs decreased by around 22%, while prices increased by 18% and total area of WHC was extended by 78000 m<sup>2</sup>. In 2007 WHC paid 8.755.280 PLN less for heating energy than in 2003

## ENERGY USAGE AND ENERGY SAVING OF BUILDINGS

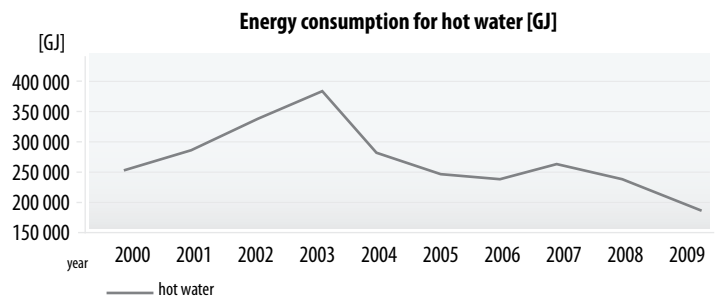
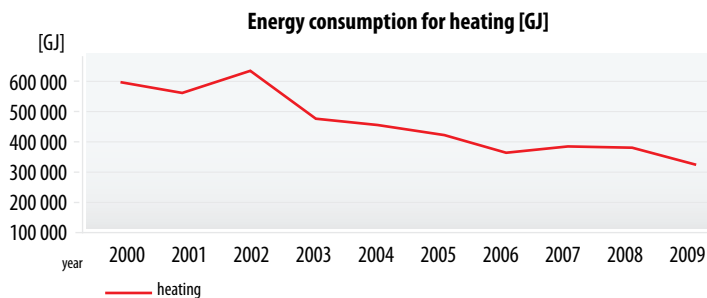

Heating energy costs in WHC in 2002-2007 in million PLN (1 million PLN app. 250<sup>th</sup> Euro)

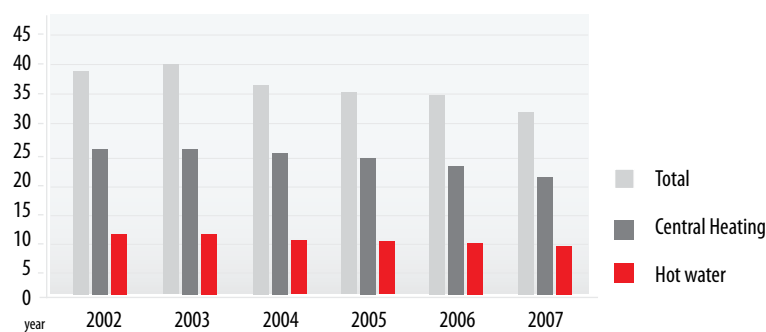

## CONCLUSION

- Due to thermo-modernisation actions in the years 2002-2007, total costs of heating energy supply were cut by 20% from 41 000 000 to 33 000 000 PLN.
- Thermo-modernisation credit enabled to carry out systematic improvements and the financial burden was not put on tenants.
- Tenants did not bear any financial risk at the moment of WHC credit application – bank had credit guarantee in the form of WHC bank accounts and incomes from non-residential area renting.
- Money, saved due to lower heating costs, was used to pay the credit.
- Except for financial aspects, heating comfort as well as appearance of the houses was improved.

With a reliable and competent supplier like Danfoss excellent results of saving energy, and thus money, can be achieved.



**Location:**  
Shanghai, China  
**Project:**  
World Expo  
Performance Centre  
**Application:**  
AB-QM for Heating  
and Cooling



**Location:**  
Gdynia, Poland  
**Project:**  
Sea Towers  
**Application:**  
AB-QM for Heating  
and Cooling



**Location:**  
Frankfurt, Germany  
**Project:**  
Deutsche Bank  
**Application:**  
AB-QM for Heating  
and Cooling



**Location:**  
Frankfurt, Germany  
**Project:**  
Tower 185  
**Application:**  
AB-QM for Heating  
and Cooling



**Location:**  
Bangalore, India  
**Project:**  
Hotel Gardenia  
**Application:**  
AB-QM for Heating  
and Cooling