

Installation guide

**Solenoid valve**

Type EV210B



032R9272

032R9272

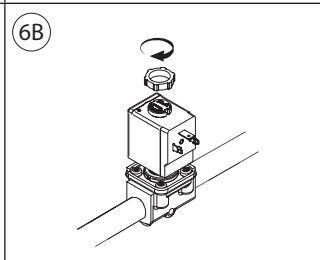
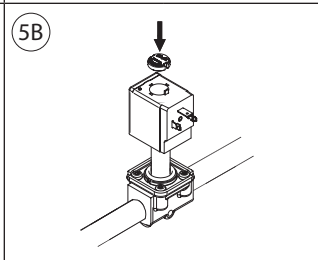
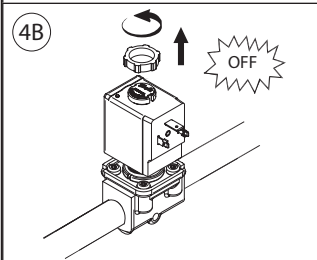
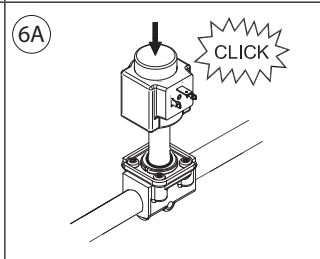
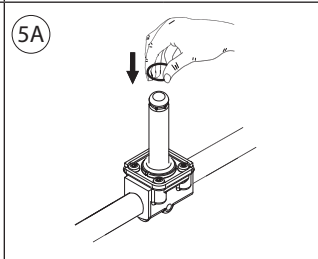
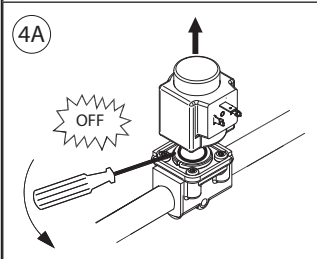
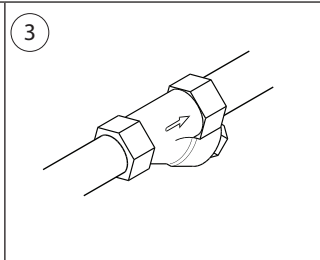
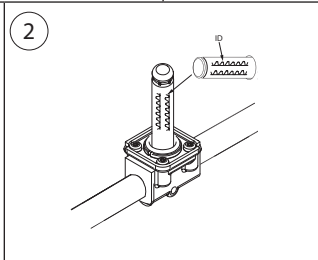
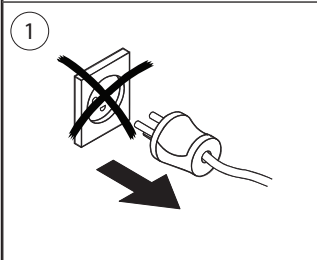
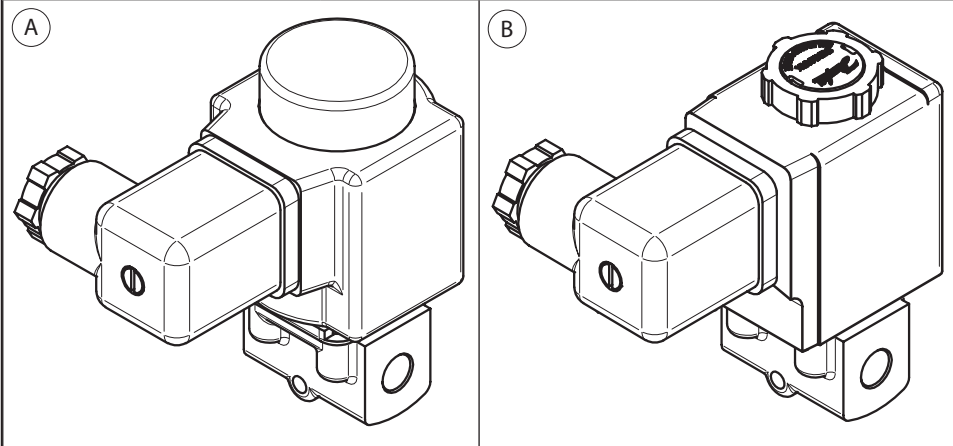

Імпортер: ТОВ з іі "Данфосс ТОВ" 04080, Київ 80, м/с 168, Україна

Info for UK customers only: Danfoss Ltd., 22 Wycombe End, HP9 1NB, GB

7

Max. 15° Max. 15°  
EV210B 15-25  
Max. 90° Max. 90°  
EV210B 4.5-10  
EV210B 1.5-3  
360°

8

Max. 15° Max. 15°  
EV210B 15-25  
Max. 90° Max. 90°  
EV210B 4.5-10  
EV210B 1.5-3  
360°

9

10

11

12

13

14

15

16

DN	MWP	Max. test pressure PT	
	[bar]	[bar]	
1.5 - 4.5	35	52.5	
6 - 10	25	37.5	
15 - 25	16	24	

EN 60730-2-8

Visit [www.products.danfoss.com](http://www.products.danfoss.com) for further technical data

Para más información, visite [www.products.danfoss.es](http://www.products.danfoss.es)

Rendez-vous sur le site [www.products.danfoss.fr](http://www.products.danfoss.fr) pour plus de données techniques

Any information, including, but not limited to information on selection of product, its application or use, product design, weight, dimensions, capacity or any other technical data in product manuals, catalogues descriptions, advertisements, etc. and whether made available in writing, orally, electronically, online or via download, shall be considered informative, and is only binding if and to the extent, explicit reference is made in a quotation or order confirmation. Danfoss cannot accept any responsibility for possible errors in catalogues, brochures, videos and other material. Danfoss reserves the right to alter its products without notice. This also applies to products ordered but not delivered provided that such alterations can be made without changes to form, fit or function of the product.

All trademarks in this material are property of Danfoss A/S or Danfoss group companies. Danfoss and the Danfoss logo are trademarks of Danfoss A/S. All rights reserved.